

S.O.ERRE



INDUSTRY
N° 5 2023



04

Dobbiamo tutto all'**aria**, che **non si vede** ma si percepisce. Avere il controllo di questo **nobile fluido** è l'obiettivo delle nostre intuizioni.

*Everything is for **air**, that **isn't visible** but is perceivable. To have the control of this **noble fluid** is the aim of our intuitions.*

ASPIRATORI ASSIALI - AXIAL FANS



AXIA LD 12



AXIA MD 14



AXIA HD 16



AXIA TT 18



AXIA TT ECO 20



AXIA AI 22



AXIA AI ECO 24



AXIA AI HP 26

DESTRATIFICATORI - DESTRATIFIERS



DES 28

ASPIRATORI CENTRIFUGHI - CENTRIFUGAL FANS



LINEAR 30



TURBO 32



TURBOPLAST 34



CB 36



CS 38



CAI 40



CAA 42



AC 44

CASSONATI - BOX FANS

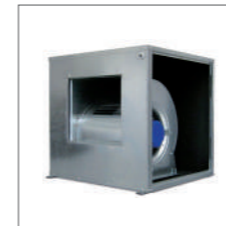

CV-D 45



CV-2P 47



CV-T 49

TORRINI - ROOF FANS



TXC 51



TXP 53



TXV 55



TXA 57



TURBOCAMINO 59

ANTIDIFLAGRANTI - EXPLOSION PROOF



CB EX-ATEX 60



CS EX-ATEX 62



EB EX-ATEX 64

VENTILATORI PER FUMI D'INCENDIO E AUTORMESSE - SMOKE EXHAUST FANS FOR FIRE AND CAR GARAGES



CVT HT 400°C 2h 66



TXP 400°C 2h 68



TXV 400°C 2h 70

ACCESSORI INDUSTRIALI - INDUSTRIAL ACCESSORIES















ACCESSORI 72

INDICE ALFABETICO – ALPHABETICAL INDEX

A	D
AC 46	DES..... 28
ACCESSORI/ACCESSORIES 74	
AXIA AI 22	E
AXIA AI ECO 24	EB EX ATEX 66
AXIA AI HP 26	
AXIA HD 16	L
AXIA LD 12	LINEAR..... 30
AXIA MD..... 14	
AXIA TT..... 18	T
AXIA TT ECO..... 20	TURBO 32
	TURBOCAMINO 61
C	TURBOPLAST 34
CAA 44	TXA 59
CAI 42	TXC 53
CB 38	TXP 55
CB EX ATEX 62	TXP 400°C 2h 70
CS..... 40	TXV 57
CS EX ATEX 64	TXV 400°C 2h 72
CVT HT 400°C 2h 68	
CV-D 47	
CV-T..... 51	
CV-2P..... 49	

SIMBOLI – SYMBOLS

 LD	Light Duty Light Duty		Motore ad alta tecnologia High technology engine
 MD	Medium Duty Medium Duty		Dimensioni ridotte Reduced dimensions
 HD	Heavy Duty Heavy Duty		Apertura a compasso Compass opening
	Risparmio energetico Energy Saving		Acciaio Inox Stainless steel
 400°C 2h	2 Ore nell'incendio a 400°C In case of fire		Staffa per fissaggio incorporata Bracket integrated
	Motore su cuscinetti Ball bearing motor for long life		Per atmosfera potenzialmente esplosiva For potential explosive atmospheres ex-atex 94/9/EC
 +70°C	Funzionamento garantito fino a +70° Working temperature up to 70°C		

ABBREVIAZIONI – ABBREVIATIONS

CARATTERISTICHE – FEATURES

M	Motori monofase Single phase motor
T	Motori trifase Three phase motor
	Prodotto in doppio isolamento elettrico Product with double electrical insulation
IPX4	Gradi di protezione secondo EN60529 Product protected against splash proof

APPROVAZIONI – APPROVALS

CE	Prodotto conforme alle Direttive CEE applicabili The product conforms to applicable EEC Directives
T 40	Temperatura ambiente di esercizio 40°C Working temperature 40°C
CB	Testato secondo lo schema CB in laboratori certificati Tested following CB international scheme in certified lab

GUIDA TECNICA – TECHNICAL GUIDE

L'AREAZIONE NEI LOCALI

La qualità dell'aria nei locali confinati (indoor), può essere causa di un vasto numero di effetti indesiderati che vanno dal malessere generale fino a complicazioni più gravi sullo stato di salute. Gli esperti hanno ampiamente dimostrato che importanti concentrazioni di inquinanti si trovano soprattutto anche all'interno degli ambienti lavorativi, degli uffici pubblici, negli edifici commerciali, troviamo ad esempio: fumo di tabacco, sudore, formaldeide, monossido di carbonio (CO₂), radon ecc... Di conseguenza, per migliorare la qualità dell'aria, è necessario aerare i locali nei quali l'uomo vive ed esplica le sue molteplici attività, proprio per questo si rende necessaria l'installazione di aspiratori che ricambino l'aria in modo graduale espellendo l'aria inquinata per immetterne di nuova.

SCEGLIERE UN ASPIRATORE

Gli aspiratori si suddividono in tre grandi categorie, differenziandosi per potenza, modalità di installazione e tipo di applicazione.

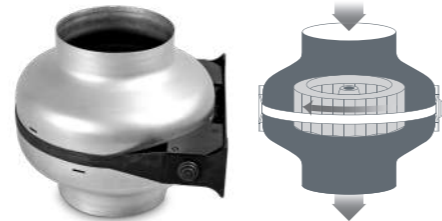
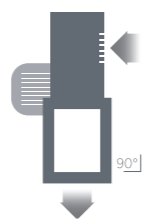

ASPIRATORI ELICOIDALI

Apparecchi assiali che muovono grandi volumi d'aria a bassa pressione. Vengono installati a vetro o a muro quando il condotto è breve e diretto all'esterno.

AXIAL FANS

Axial fans moving large air volumes at low pressure to extract air directly outside or through short ducts up to 1 meter maximum length.

ASPIRATORI CENTRIFUGHI

Apparecchi radiali che muovono limitati volumi d'aria a pressione elevata. Sono in grado di spostare la colonna d'aria in lunghi condotti vincendo le resistenze di curve, strozzature e irregolarità delle superfici interne. Vengono installati in caso di condotti lunghi e tortuosi.

CENTRIFUGAL FANS

Centrifugal fans moving limited air volumes at high pressure achieving a good flow against the resistance created in a duct system, with bends and elbows or wrinkled duct. Particularly useful to ventilate areas with long ducting.

ASPIRATORI CENTRIFUGHI IN LINEA

Apparecchi che utilizzano una girante centrifuga dove l'aria viene convogliata in senso assiale e non radiale dalla stessa struttura che costituisce il corpo del prodotto. In grado di sviluppare elevate pressioni, sono concepiti per essere installati in qualunque punto lungo il condotto.

IN-LINE CENTRIFUGAL FANS

Fans equipped with centrifugal impeller to convey air in axial direction instead of radial. This product category is able to generate high pressure and is conceived to be placed in any point of the duct.

VENTILATING THE ROOMS

The air quality in confined spaces (indoor), can cause different unpleasant effects reactions from general malaise to more serious complications on health status. Experts have widely shown that huge concentrations of pollutants like tobacco, smoke, sweat, formaldehyde, carbon monoxide (CO₂), radon, etc... can be found in work environments, in public offices, commercial buildings.

To improve the quality of air we breath, it is necessary to ventilate the rooms where people live and carry out their several activities. Hence the need to install a fan.

HOW TO SELECT FAN

Fans are divided into three main categories, differing in power, installation and type of application.

To have a correct ventilation is essential to select the most suitable fan in accordance with the main features of the room and type of application. The table shown in the following pages states the criteria how to determine the required flow rate in any condition.

In case of duct installation refer to the diagram below to calculate the pressure losses.

The recommended air changes here below have to be considered as an approximate indication only. For further information please refer to the local country rules. The following values are drawn from Prospect III contained in UNI 10339:95 standard. The values in m³/h were obtained from corresponding values in l/s (multiplying the value by 3,6) and have been rounded.

Refer to the table below for the recommended air changes per hour based upon room type.

- The calculation based on the "crowding", is carried out by multiplying the air changes per hour per person by the number of people present in the room;
- The calculation based on the "surface", is carried out by multiplying the air changes per hour by the room's surface in square meter;
- The calculation based on the "volume", is obtained by multiplying the value in the table by the volume of the room in cubic meter.

The air must be extracted from technical areas such as kitchens, bathrooms, services and therefore must be kept in vacuum.

CALCOLARE LA PORTATA D'ARIA CALCULATING AIR FLOW

PROSPETTO RICAMBI D'ARIA ESTERNA PER EDIFICI CIVILI AIR CHANGES PER HOUR RECOMMENDED FOR CIVIL BUILDINGS

	CATEGORIA DI EDIFICI ROOMS' CATEGORY	PORTATA D'ARIA D'ESTRAZIONE – AIR FLOW RATE				
		IN BASE ALL'AFFOLLAMENTO RICAMBI PER PERSONA AIR CHANGES PER PERSONA REF. NO. PEOPLE		IN BASE ALLA SUPERFICIE RICAMBI PER mq AIR CHANGES PER m ² REF. m ²		IN BASE AL VOLUME N° RICAMBI PREVISTI PER ORA REF. VOLUME AIR CHANGES PER HOUR
		l/s	m ³ /h	l/s	m ³ /h	
ABITAZIONI CIVILI HOUSES	Soggiorni e camere da letto Bedrooms, living rooms	11	40			
	Cucine, bagni, servizi Kitchens, bathrooms, services					4
	Sale riunioni Meeting rooms	9	33			
ABITAZIONI COLLETTIVE FLATS	Camere Bedrooms	11	40			
	Cucine, bagni, servizi Kitchens, bathrooms, services			16,5	60	
	Bagni, servizi Bathrooms, services					4
EDIFICI RESIDENZIALI RESIDENTIAL BUILDINGS	Ingresso, soggiorni Hall, living rooms	11	40			
	Sale conferenza Meeting rooms	5,5	20			
	Sale da pranzo Dining rooms	10	36			
	Camere Bedrooms	11	40			
	Bagni di camere Bathrooms					4
	Servizi Services					8
UFFICI OFFICES	Singoli Office	11	40			
	Open space Open space	11	40			
	Locali riunioni Meeting rooms	10	36			
	Centro elaborazione dati Data processing center	7	26			
	Servizi Services					8
OSPEDALI, CLINICHE, CASE DI CURA HOSPITALS, CLINICS, NURSING HOMES	Degenze Rooms	11	40			
	Corse Wards	11	40			
	Camere sterili Sterile environment	11	40			
	Sale mediche, soggiorni Medical rooms, living rooms	8,5	31			
	Terapie fisiche Physical therapy	11	40			
	Servizi Services					8
CINEMA, TEATRI, SALE PER CONGRESSI CINEMA THEATERS, CONFERENCE HALLS	Aree pubbliche, sale (no fumatori) Public areas, rooms (no smoking)	5,5	20			
	Palcoscenici, studi TV Stages, TV studio	12,5	45			
	Sale riunioni con fumatori Meeting rooms (smokers)	10	36			
	Servizi Services					8
	Borse titoli Stock market	10	36			
	Sale d'attesa Waiting rooms					8
MUSEI, BIBLIOTECHE E LUOGHI DI CULTO MESEUMS, LIBRARIES AND PLACES OF WORSHIP	Sale mostre Exhibition halls	6	22			
	Sale lettura Reading rooms	5,5	20			
	Depositi libri Book stores			1,5	6	
	Luoghi di culto Worship, churches	6	22			
	Servizi Services					8
EDIFICI PUBBLICI PUBLIC BUILDINGS	Bar Bars	11	40			
	Pasticcerie Pastry shops	6	22			
	Sale da pranzo Dining rooms	10	36			
	Sale da ballo Ballrooms	16,5	60			
	Cucine Kitchens			16,5		
	Servizi Services					8
PISCINE, SAUNE SWIMMING POOL, SAUNA	Sala vasca Swimming pool			2,5		
	Spogliatoio, servizi Dressing room, services					8
	Sauna Sauna			2,5		
PALESTRE GYMS	Palazzetti sportivi Sports halls	6,5	23			
	Bowling Bowling	10	36			
	Campi da gioco Playing fields	16,5	59			
	Zone spettatori Spectator areas	6,5	23			
	Spogliatoio, servizi Changing rooms, services					8
	Servizi pubblici Public services					8
EDIFICI SCOLASTICI SCHOOL BUILDINGS	Asili nido, scuole materne Nursery school	4	14			
	Aule scuole elementari Primary school	5	18			
	Aule scuole medie inferiori Junior high school	6	22			
	Aule scuole medie superiori Secondary school	7	25			
	Aule universitarie University	7	25			
	Servizi Services					8
	Biblioteche, sale lettura Libraries, reading rooms	6	22			
	Aule musica e lingua Music room	7	25			
	Laboratori Laboratories	7	25			
Sale insegnanti Teachers' room	6	22				
GRANDI MAGAZZINI DEPARTMENT STORES	Piani interrati Basements	9	33			
	Piani superiori Upper floors	6,5	24			
	Barbieri, parrucchieri Barbers, hairdresser	14	51			
	Abbigliamento, calzature, mobili, ottici, fioristi, fotografi Clothing footwear, furniture, opticians, florist, photographers	11,5	42			
	Alimentari, lavasecco, farmacie Foodstuffs, drycleaners, pharmacies	9	33			
	Servizi Services					8
EDIFICI COMMERCIALI COMMERCIAL BUILDINGS	Zone pubbliche di banche, quartieri fieristici Areas of public banks, exhibition centers	10	36			

L'aria deve essere estratta dai locali tecnici quali cucine, bagni e servizi che quindi devono essere tenuti in depressione.

DIAGRAMMA PER LA SCELTA DELL'ASPIRATORE DIAGRAM FOR FAN CHOICE

PERDITE DI CARICO PER CURVE E GOMITI - LOSSES FOR BENDS AND ELBOWS

● Diametro del condotto in mm / Duct diameter in mm
● Portata m³/h / Flow rate m³/h
● Perdite di carico in mm H₂O per metro di condotto / Pressure losses in mm H₂O per meter of duct
● Velocità m/s / Air speed m/s

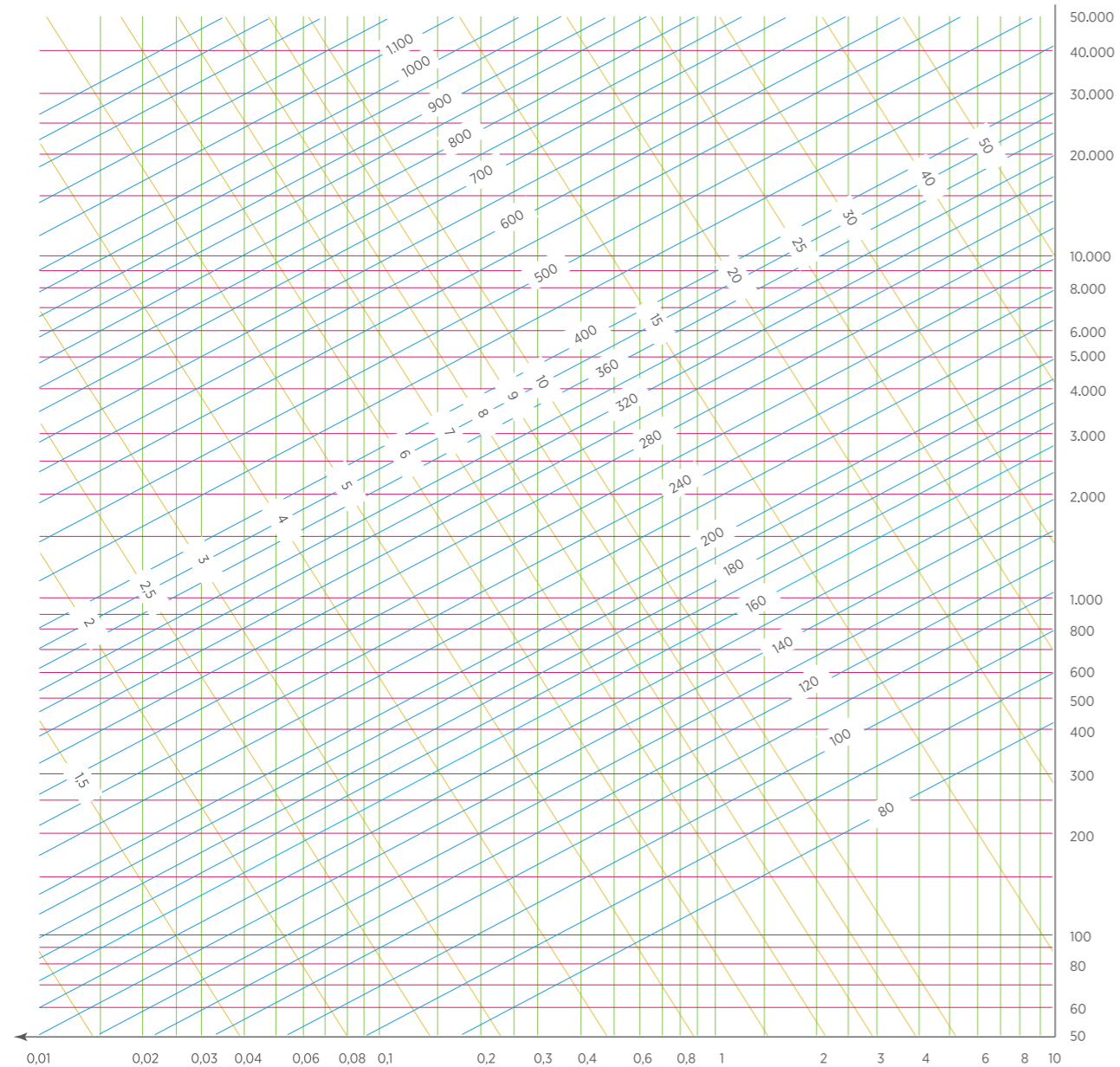

COME SI USA IL DIAGRAMMA?

- 1) Scegli sul lato destro del diagramma il valore della Portata (m³/h);
- 2) Prosegui in orizzontale fino ad incrociare la linea in diagonale del Diametro del condotto con il valore d'interesse;
- 3) Scendi in verticale per trovare il valore della Perdita di carico in millimetri di colonna d'acqua per ogni metro di tubazione. Moltiplicando questo valore per la lunghezza della tubazione si trova la perdita totale; se si desidera il valore in Pa occorre moltiplicare il valore ottenuto per 9,81.
- 4) Dal punto 2 individuando all'incrocio la linea gialla si trova il valore della Velocità dell'aria in m/s, che serve per utilizzare la tabella A.

HOW TO USE THE DIAGRAM:

- 1) Start with the flow rate value (m³/h) on the right side of the diagram.
- 2) Proceed horizontally until you cross the diagonal line giving you the diameter of the duct you need.
- 3) Descend vertically to find the value of the pressure loss expressed in mm H₂O per each meter of duct. Multiply this value with the required length of pipe and you will find the total pressure loss value. If you want the value in Pa, multiply the value by 9,81.
- 4) At the intersection of the flow rate and duct diameter values, follow this line upwards until it intersects with the recommended air speed (m/sec). Once you have this value refer to Table A.

VELOCITÀ (m/sec) SPEED (m/sec)	1	2	3	4	5	6	7	8	9	10	15	20	30
PERDITA DI CARICO CURVA (mm H ₂ O) - PRESSURE LOSS FOR BEND (mm H ₂ O)	0,01	0,05	0,1	0,2	0,3	0,4	0,5	0,7	0,9	1,1	2,5	4,5	10
PERDITA DI CARICO GOMITO (mm H ₂ O) - PRESSURE LOSS FOR ELBOW (mm H ₂ O)	0,1	0,35	0,8	1,4	2	3	4	5,5	7	9	20	35	65

**CATALOGO INDUSTRY
INDUSTRY CATALOGUE**



AXIA LD – light duty

ASPIRATORE ASSIALE – AXIAL FAN

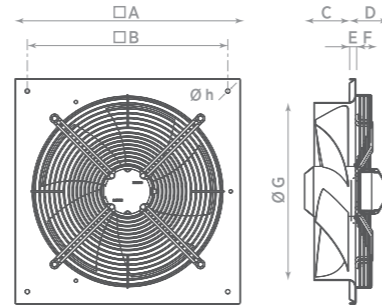

MODELLO MODEL	A	B	C	D	E	F	G	h
LD 20 4	280	265	55	73	8,5	27	208	8,3
LD 25 4	340	325	66	83	8,5	27	259	8,3
LD 30 4	390	375	75	100	10	47	311	8,3
LD 35 4	460	439	85	106	12	53	363	12,3



Aspiratori elicoidali per per impieghi non particolarmente gravosi. Applicazione a parete o a pannello per convogliare aria direttamente all'esterno o in brevi condotti.

- Aspiratori leggeri e compatti con ingombri limitati;
- Temperatura max aria aspirata: 40°C;
- Griglia anti-infortunistica;
- Corpo e griglia in acciaio verniciato a forno con polveri epossidiche anti corrosione;
- Ventola in alluminio;
- Dotato di cavo di collegamento;
- Motore asincrono monofase con protezione termica, grado di protezione motore IP42;
- Velocità regolabile tramite i regolatori industriali (opzionali);
- Conforme alle direttive comunitarie vigenti ed alla NORMA UNI EN ISO 13857; UNI EN ISO 12499; CEI EN 60204 – 1;
- **POSIZIONAMENTO:** a muro

Axial fans for light duty, wall or panel mounting to convey air directly outside or through short duct.

- Light and compact fans with reduced overall dimensions;
- Max temperature of extracted air: 40°C;
- Safety protection grille;
- Body and grille in steel protected by an epoxy-based anticorrosive paint;
- Impeller in aluminium;
- Equipped with cable connection;
- Single-phase IP42 thermally protected motor;
- Motor speed can be regulated through industrial controllers (see accessories);
- In accordance with the essential requirements of 2006/42/EC Directive concerning machines and European Standards UNI EN ISO 13857; UNI EN ISO 12499; CEI EN 60204-1;
- **POSITIONING:** wall mounting



DATI TECNICI – TECHNICAL DATA

MODELLO MODEL	CODICE CODE	MOTORE MOTOR	N° POLI N° POLES	GIRI AL MINUTO REV./MINUTE (RPM)	TENSIONE VOLTAGE (Volt)	FREQUENZA FREQUENCY (Hz)	PORTATA FLOW RATE (m³/h)	PRESS.MAX MAX PRESS. (mmHg)	PRESS.MAX MAX PRESS. (Pa)	POTENZA POWER (W)	CORR. NOM. NOM. CORR. (A)	IP MOTORE IP MOTOR	RUMOROSITÀ NOISE dB(A) _{1m}	PESO WEIGHT (kg)
AXIA LD 20 4M	0073301	single p.	4	1400	230	50	550	5,1	50	30	0,2	IP42	34	2,3
AXIA LD 25 4M	0073302	single p.	4	1400	230	50	1100	10,2	100	55	0,4	IP42	40	3,2
AXIA LD 30 4M	0073303	single p.	4	1400	230	50	1400	6,6	65	70	0,5	IP42	46	4
AXIA LD 35 4M	0073304	single p.	4	1400	230	50	1700	5,6	55	72	0,5	IP42	49	5,1

AMBITI APPLICATIVI

Indicato per installazione prevalentemente in ambito industriale:

- Industrie
- Capannoni e magazzini
- Cucine e mense
- Impianti sportivi
- Supermercati e centri commerciali
- Locali gruppo frigo

Adatti anche per applicazioni su macchinari dove è necessaria una ventilazione o aspirazione forzata.

ENVIRONMENTS APPLICATION

Suitable for installation in industrial environment such as:

- Industries
- Sheds
- Warehouses
- Kitchen
- Refectories
- Sports facilities
- Supermarkets
- Shopping centers
- Cooling power plants

Also suitable for application on machines where a forced ventilation or air suction is required.



GRAFICI DI PORTATA – FLOW CHARTS

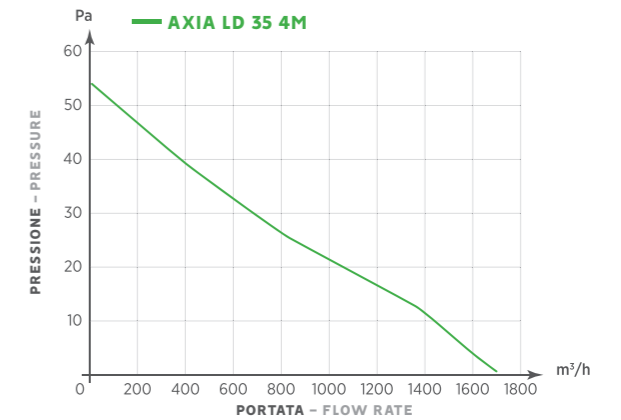
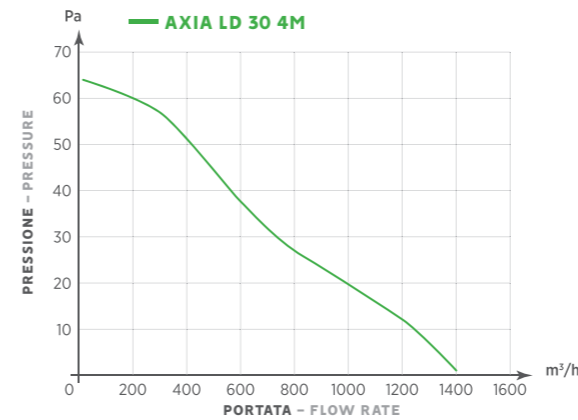
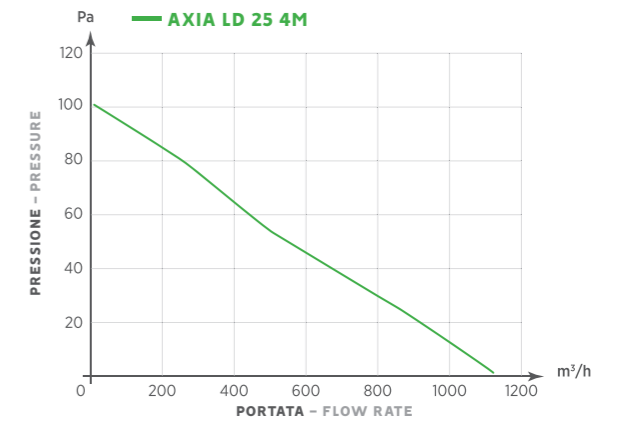
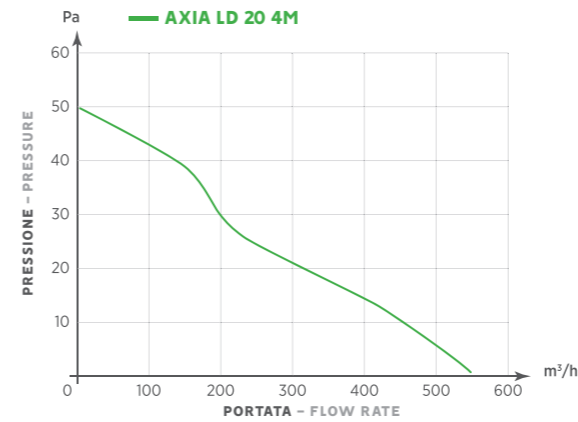

ACCESSORI (PAGINA 72, 74) – ACCESSORIES (PAGE 72, 74)



Regolatori
Controllers



Serranda a gravità
Gravity Shutter



Griglie di protezione
Protection Grill



Distanziale
Spacer

AXIA MD – medium duty

ASPIRATORE ASSIALE – AXIAL FAN

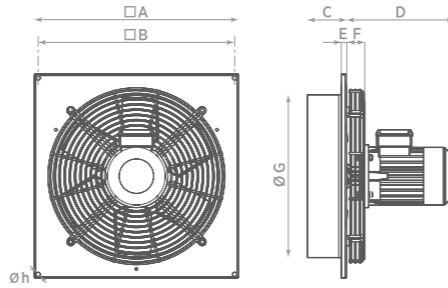

MODELLO MODEL	A	B	C	D	E	F	G	H
MD 25 4	340	325	66	207	8.5	35	259	8.3
MD 30 4	390	375	75	207	10	35	311	8.3
MD 35 4	460	439	85	181	12	-	363	12.3
MD 40 4	510	490	86	181	12	-	413	12.3
MD 50 6	630	610	101	223	15	-	513	12.3
MD 50 4	630	610	101	204	15	-	513	12.3
MD 60 6	815	781	126	223	15	-	638	12.3
MD 60 4	815	781	126	224	15	-	638	12.3



Aspiratori elicoidali per impieghi mediamente gravosi. Applicazione a parete o a pannello per convogliare aria direttamente all'esterno o in brevi condotti.

- Temperatura max aria aspirata: 60°C;
- Griglia anti-infortunistica;
- Corpo e griglia in acciaio verniciato a forno con polveri epossidiche anti corrosione;
- Ventola in nylon a profilo alare ad alto rendimento;
- Prodotto di lunga durata grazie all'utilizzo di un motore ad induzione montato su cuscinetti a sfera, grado di protezione motore IP55, isolamento in classe F;
- Reversibilità: tutti;
- Versione con flusso d'aria inverso a richiesta;
- Velocità regolabile tramite i regolatori industriali (opzionali);
- Conforme alle direttive comunitarie in vigore ed alla NORMA UNI EN ISO 13587; UNI EN ISO 12499; CEI EN 60204 - 1;
- **POSIZIONAMENTO:** a muro

Axial fans for medium duty, wall or panel mounting to convey air directly outside or through short duct.

- Max temperature of the extracted air: 60°C;
- Safety protection grille;
- Body and grille in steel protected by an epoxy-based anticorrosive paint;
- Airfoil impeller in nylon material;
- Ball bearing class F insulation motor IP55 protected;
- Motor speed can be regulated through industrial controllers (see accessories);
- Reversibility: all models;
- Standard airflow is from motor to impeller, the opposite direction available on request;
- In accordance with the essential requirements of 2006/42/EC Directive concerning machines and European Standards UNI EN ISO 13587; UNI EN ISO 12499; CEI EN 60204-1.
- **POSITIONING:** wall mounting.

DATI TECNICI – TECHNICAL DATA

MODELLO MODEL	CODICE CODE	MOTORE MOTOR	N° POLI N° POLES	GIRI AL MINUTO REV./MINUTE (RPM)	TENSIONE VOLTAGE (VOLT)	FREQUENZA FREQUENCY (Hz)	PORT. MAX FLOW RATE (m³/h)	PRESS. MAX MAX PRESS. (mmHg)	PRESS. MAX MAX PRESS. (Pa)	POTENZA POWER (W)	CORR. NOM. NOM. CURR. 230V 400V	IP MOTORE IP MOTOR	RUMOROSITÀ NOISE dB(A) _{1m}	PESO WEIGHT (kg)
AXIA MD 25 4M	0073001	single p.	4	1400	230	50 - 60	1200	11,2	110	80	0,6 -	IP55	46	5,7
AXIA MD 30 4M	0073003	single p.	4	1400	230	50 - 60	1800	13,8	135	100	0,7 -	IP55	50	6,4
AXIA MD 35 4M	0073005	single p.	4	1400	230	50 - 60	2400	14,3	140	115	0,7 -	IP55	55	7,2
AXIA MD 40 4M	0073007	single p.	4	1350	230	50 - 60	3500	17,3	170	120	0,9 -	IP55	60	8
AXIA MD 50 4M	0073011	single p.	4	1400	230	50 - 60	6200	18,4	180	240	1,4 -	IP55	65	10,6
AXIA MD 50 6M	0073013	single p.	6	850	230	50 - 60	3900	6,6	65	110	0,4 -	IP55	55	10,8
AXIA MD 60 4M	0073015	single p.	4	1350	230	50 - 60	9000	19,4	190	270	1,7 -	IP55	70	11,5
AXIA MD 60 6M	0073017	single p.	6	750	230	50 - 60	5200	6,1	60	120	0,45 -	IP55	56	14,7
AXIA MD 25 4T	0073002	three p.	4	1400	230/400	50 - 60	1200	11,2	110	80	0,6 0,3	IP55	46	5,7
AXIA MD 30 4T	0073004	three p.	4	1400	230/400	50 - 60	1800	13,8	135	100	0,7 0,4	IP55	50	6,4
AXIA MD 35 4T	0073006	three p.	4	1400	230/400	50 - 60	2400	14,3	140	115	0,7 0,4	IP55	55	7,2
AXIA MD 40 4T	0073008	three p.	4	1350	230/400	50 - 60	3500	17,3	170	120	0,8 0,5	IP55	60	7,9
AXIA MD 50 4T	0073012	three p.	4	1400	230/400	50 - 60	6200	18,4	180	240	1,3 0,8	IP55	65	10,6
AXIA MD 50 6T	0073014	three p.	6	850	230/400	50 - 60	3900	6,6	65	110	0,37 0,21	IP55	55	10,8
AXIA MD 60 4T	0073016	three p.	4	1350	230/400	50 - 60	9000	19,4	190	270	1,4 0,8	IP55	70	11,5
AXIA MD 60 6T	0073018	three p.	6	750	230/400	50 - 60	5200	6,1	60	120	0,43 0,25	IP55	56	14,7

AMBITI APPLICATIVI

Indicato per installazione prevalentemente in ambito industriale:

- Industrie
- Capannoni e magazzini
- Serre ed allevamenti
- Parcheggi
- Cucine e mense
- Impianti sportivi
- Locali gruppo frigo o elettrogeno
- Cabine elettriche
- Supermercati e centri commerciali

Adatti anche per applicazioni su macchinari dove è necessaria una ventilazione o aspirazione forzata.

ENVIRONMENTS APPLICATION

Suitable for installation in industrial environment such as:

- Industries
- Sheds and Warehouses
- Greenhouse and Breeding
- Parking
- Kitchen and Refectories
- Sports facilities
- Electrical generator rooms
- Electrical cabinets
- Supermarkets and Shopping centers

Also suitable for application on machines where a forced ventilation or air suction is required.

GRAFICI DI PORTATA – FLOW CHARTS

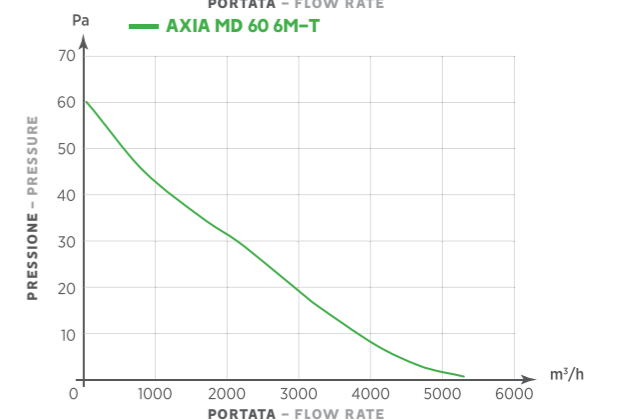
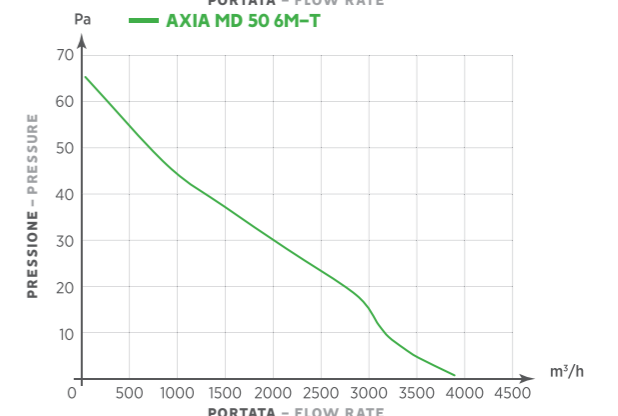
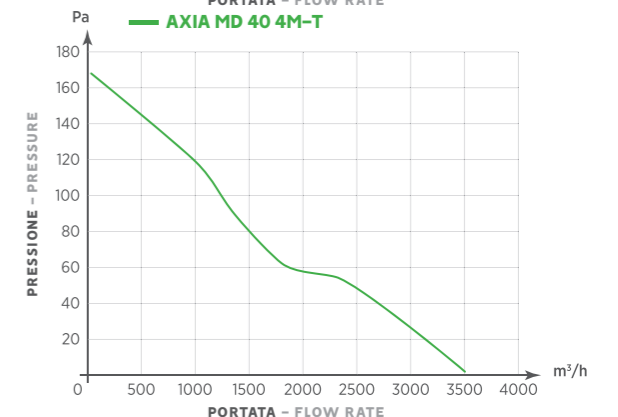
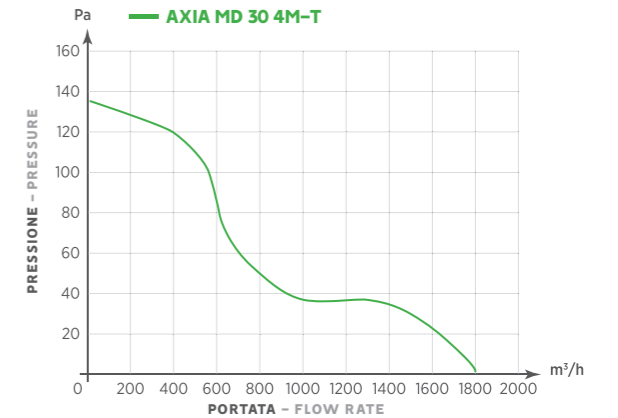
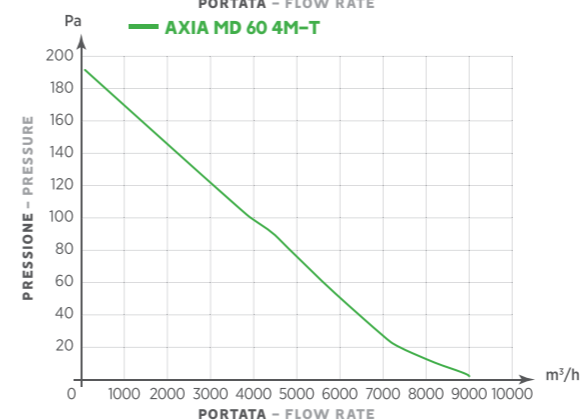
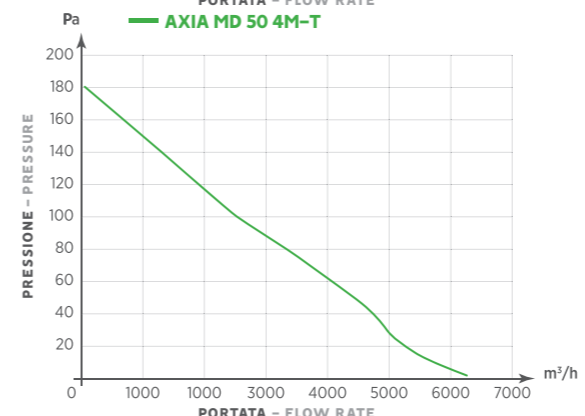
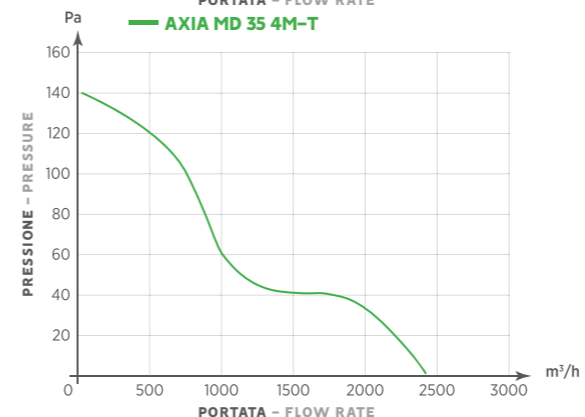
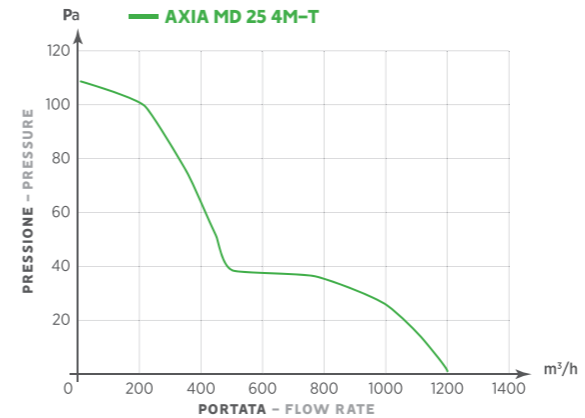

ACCESSORI (PAGINA 72, 74) – ACCESSORIES (PAGE 72, 74)



Regolatori
Controllers



Serranda a gravità
Gravity Shutter



Griglie di protezione
Protection Grill



Distanziale
Spacer

AXIA HD – heavy duty

ASPIRATORE ASSIALE – AXIAL FAN

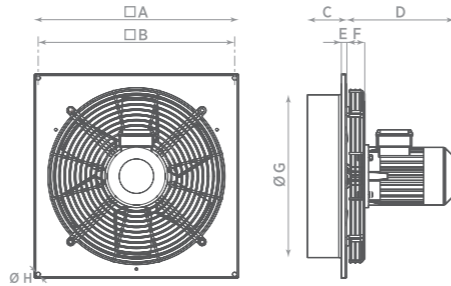

MODELLO MODEL	A	B	C	D	E	F	G	H
HD 25 4	340	325	66	207	8.5	35	259	8.3
HD 30 4	390	375	75	207	10	35	311	8.3
HD 35 4	460	439	85	181	12	-	363	8.3
HD 40 4	510	490	86	204	12	-	413	12.3
HD 50 6	630	610	101	223	15	-	513	12.3
HD 50 4	630	610	101	204	15	-	513	12.3
HD 60 4	815	781	126	224	15	-	638	12.3



Aspiratori elicoidali per impieghi gravosi e portate d'aria elevate. Applicazione a parete o a pannello per convogliare aria direttamente all'esterno o in brevi condotti.

- Temperatura max aria aspirata + 60 °C;
- Griglia anti-infortunistica;
- Corpo e griglia in acciaio verniciato a forno con polveri epossidiche anti corrosione;
- Ventola in nylon a profilo alare ad alto rendimento;
- Prodotto di lunga durata grazie all'utilizzo di un motore ad induzione montato su cuscinetti a sfera, grado di protezione motore IP55, isolamento in classe F;
- Reversibilità: tutti;
- Versione con flusso d'aria inverso a richiesta;
- Velocità regolabile tramite i regolatori industriali (opzionali);
- Conforme alle direttive comunitarie in vigore ed alla NORMA UNI EN ISO 13857; UNI EN ISO 12499; CEI EN 60204 - 1.
- **POSIZIONAMENTO:** a muro

Axial fans for heavy duty, with high airflow capacity, wall or panel mounting to convey air directly outside or through short duct.

- Max temperature of the extracted air: 60°C;
- Safety protection grille
- Body and grille in steel protected by an epoxy-based anticorrosive paint;
- Airfoil impeller in nylon material;
- Ball bearing class F insulation motor IP55 protected;
- Motor speed can be regulated through industrial controllers (see accessories);
- Reversibility: all models;
- Standard airflow is from motor to impeller, the opposite direction available on request;
- In accordance with the essential requirements of 2006/42/EC Directive concerning machines and European Standards UNI EN ISO 13857; UNI EN ISO 12499; CEI EN 60204-1.
- **POSITIONING:** wall mounting.

DATI TECNICI – TECHNICAL DATA

MODELLO MODEL	CODICE CODE	MOTORE MOTOR	N° POLI N° POLES	GIRI AL MINUTO REV./MINUTE (RPM)	TENSIONE VOLTAGE (Volt)	FREQUENZA FREQUENCY (Hz)	PORT. MAX FLOW RATE (m³/h)	PRESS. MAX MAX PRESS. (mmHg)	PRESS. MAX MAX PRESS. (Pa)	POTENZA POWER (W)	CORR. NOM. NOM. CURR. 230V 400V	IP MOTORE IP MOTOR	RUMOROSITÀ NOISE dB(A) _{1m}	PESO WEIGHT (kg)
AXIA HD 25 4M	0073101	single p.	4	1400	230	50 - 60	1450	12,2	120	90	0,6 -	IP55	47	5,7
AXIA HD 30 4M	0073103	single p.	4	1400	230	50 - 60	2150	14,8	145	120	0,7 -	IP55	52	6,4
AXIA HD 35 4M	0073105	single p.	4	1350	230	50 - 60	2900	15,8	155	150	0,9 -	IP55	57	7,2
AXIA HD 40 4M	0073107	single p.	4	1400	230	50 - 60	4400	19,4	190	280	1,4 -	IP55	61	9
AXIA HD 50 4M	0073111	single p.	4	1300	230	50 - 60	7500	19,9	195	420	1,9 -	IP55	68	10,6
AXIA HD 50 6M	0073113	single p.	6	800	230	50 - 60	4400	6,1	60	120	0,4 -	IP55	56	10,8
AXIA HD 60 4M	0073115	single p.	4	1400	230	50 - 60	12000	20,4	200	650	3 -	IP55	74	16,4
AXIA HD 25 4T	0073102	three p.	4	1400	230/400	50 - 60	1450	12,2	120	90	0,7, 0,3	IP55	47	5,7
AXIA HD 30 4T	0073104	three p.	4	1400	230/400	50 - 60	2150	14,8	145	120	0,7, 0,4	IP55	52	6,5
AXIA HD 35 4T	0073106	three p.	4	1350	230/400	50 - 60	2900	15,8	155	150	0,8, 0,5	IP55	57	7,2
AXIA HD 40 4T	0073108	three p.	4	1400	230/400	50 - 60	4400	19,4	190	280	1,3, 0,7	IP55	61	8,5
AXIA HD 50 4T	0073112	three p.	4	1300	230/400	50 - 60	7500	19,9	195	420	1,6, 0,9	IP55	68	10,6
AXIA HD 50 6T	0073114	three p.	6	800	230/400	50 - 60	5200	6,1	60	120	0,38, 0,22	IP55	56	10,8
AXIA HD 60 4T	0073116	three p.	4	1400	230/400	50 - 60	12000	20,4	200	650	2,2, 1,3	IP55	74	16,4

AMBITI APPLICATIVI

Indicato per installazione prevalentemente in ambito industriale:

- Industrie
- Capannoni e magazzini
- Serre ed allevamenti
- Parcheggi
- Cucine e mense
- Impianti sportivi
- Supermercati e centri commerciali
- Locali gruppo frigo o elettrogeno
- Cabine elettriche

Adatti anche per applicazioni su macchinari dove è necessaria una ventilazione o aspirazione forzata.

ENVIRONMENTS APPLICATION

Suitable for installation in industrial environment such as:

- Industries
- Sheds and Warehouses
- Greenhouses and breeding
- Parking
- Kitchens and Refectories
- Sports facilities
- Supermarkets and Shopping centers
- Cooling power plants
- Electrical generator rooms
- Electrical cabinets

Also suitable for application on machines where a forced ventilation or air suction is required.



GRAFICI DI PORTATA – FLOW CHARTS

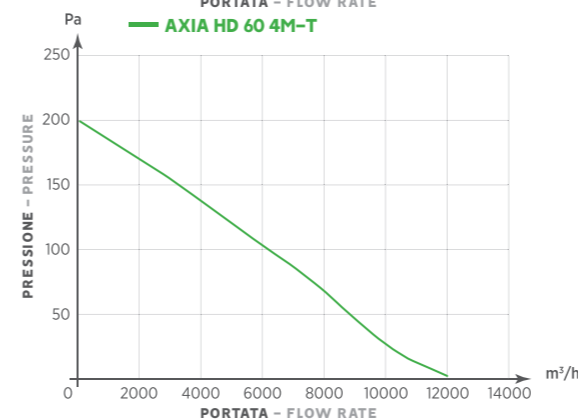
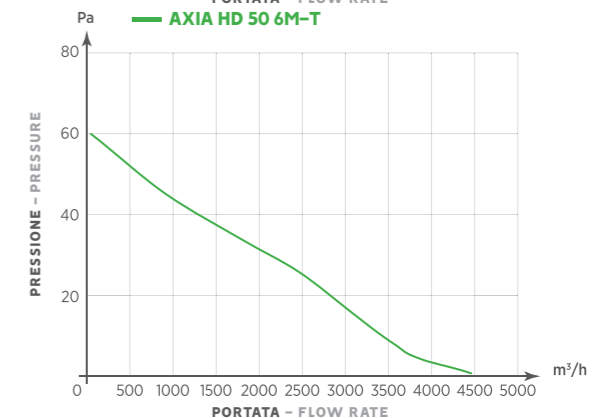
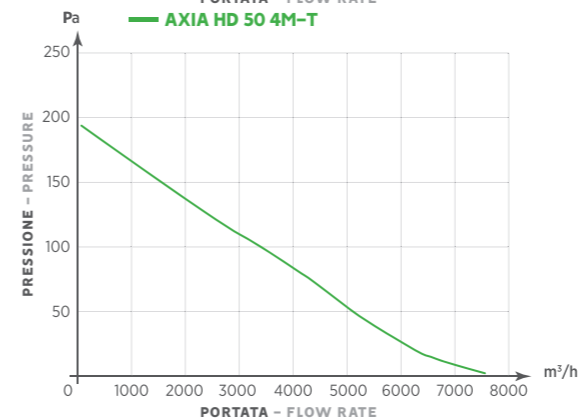
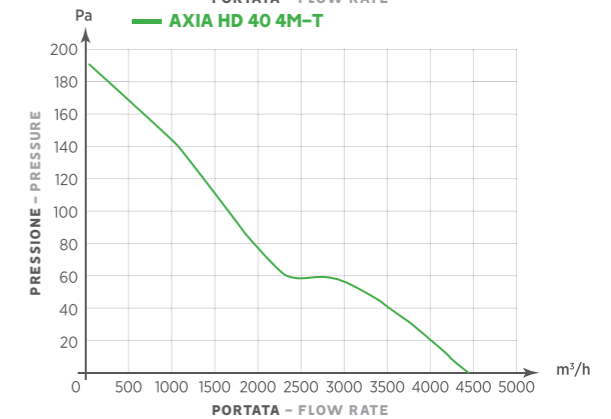
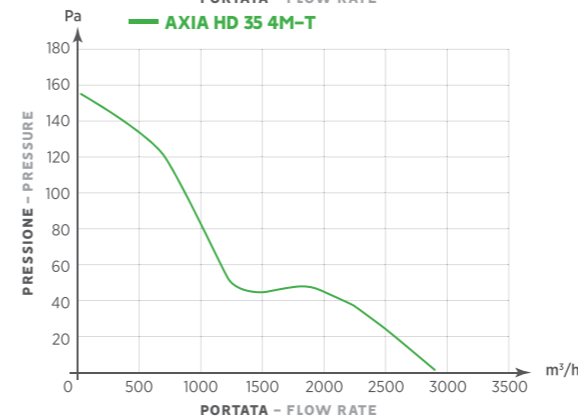
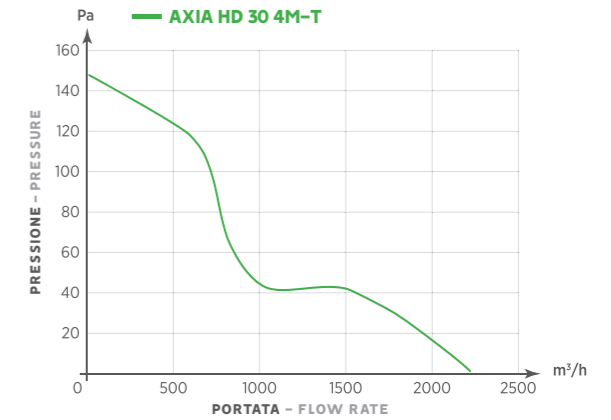
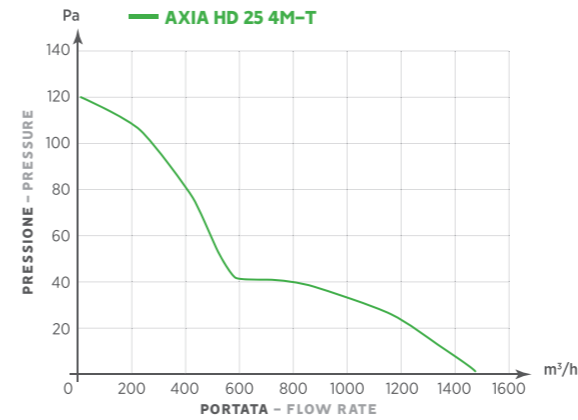

ACCESSORI (PAGINA 72, 74) – ACCESSORIES (PAGE 72, 74)



Regolatori
Controllers



Serranda a gravità
Gravity Shutter



Griglie di protezione
Protection Grill



Distanziale
Spacer

AXIA TT – techno type

ASPIRATORE ASSIALE – AXIAL FAN

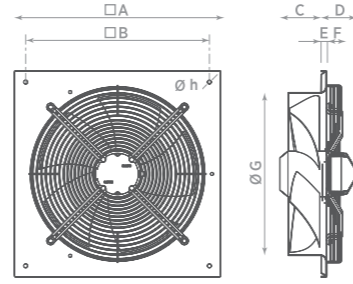

MODELLO MODEL	A	B	C	D	E	F	G	h
TT 20 2/4	280	265	55	64	8.5	-	208	8.3
TT 25 4	340	325	66	64	8.5	-	259	8.3
TT 30 4	390	375	75	93	10	57.5	311	8.3
TT 35 4	460	439	85	67	12	35	363	12.3
TT 40 4	510	490	86	67	12	35	413	12.3
TT 50 4	630	610	101	96	15	77	513	12.3
TT 60 4	815	781	126	83	15	65	638	12.3



Aspiratori elicoidali ad elevate prestazioni con motore ad alta tecnologia. Applicazione a parete o a pannello per convogliare aria o esalazioni direttamente all'esterno o in brevi condotti.

- Aspiratori compatti con ingombri limitati;
- Bassa rumorosità in rapporto alle elevate prestazioni;
- Temperatura max aria aspirata: 60°C;
- Griglia anti-infortunistica;
- Corpo e griglia in acciaio verniciato a forno con polveri epossidiche anti corrosione;
- Ventola in lamiera d'acciaio verniciato o in materiale plastico, equilibrata staticamente e dinamicamente.
- Prodotto di lunga durata grazie all'utilizzo di un motore ad induzione a rotore esterno montato su cuscinetti a sfera, isolamento in classe B o F;
- Reversibilità: tutti tranne i modelli 20 4M e 25 4M;
- Velocità regolabile tramite i regolatori industriali (opzionali);
- Conforme alle direttive comunitarie vigenti e alla NORMA UNI EN ISO 13857; UNI EN ISO 12499; CEI EN 60204 - 1.
- POSIZIONAMENTO:** a muro

Axial fans high performances with high tech motor, wall or panel mounting to convey air or fumes directly outside or through short duct.

- Max temperature of the extracted air: 60°C;
- Compact fans with reduced overall dimensions;
- Low sound level compared with high performance;
- Safety protection grille;
- Body and impeller in steel protected by an epoxy-based anticorrosive paint;
- Motor impeller with external rotor, statically and dynamically balanced;
- Ball bearing class F insulation motor, IP44 or IP54 protected (depending on the model);
- Motor speed can be regulated through industrial controllers (see accessories);
- Reversibility, all models except 20 4M and 25 4M;
- In accordance with the essential requirements of 2006/42/EC Directive concerning machines and European Standards UNI EN ISO 13857; UNI EN ISO 12499; CEI EN 60204-1.
- POSITIONING:** wall mounting.

DATI TECNICI – TECHNICAL DATA

MODELLO MODEL	CODICE CODE	MOTORE MOTOR	N° POLI N° POLES	GIRI AL MINUTO REV./MINUTE (RPM)	TENSIONE VOLTAGE (Volt)	FREQUENZA FREQUENCY (Hz)	PORT. MAX FLOW RATE (m³/h)	PRESS. MAX MAX PRESS. (mmH ₂ O)	PRESS. MAX MAX PRESS. (Pa)	POTENZA POWER (W)	CORR. NOM. NOM. CURR. 230V 400V	IP MOTORE IP MOTOR	RUMOROSITÀ NOISE dB(A) _{1m}	PESO WEIGHT (kg)
AXIA TT 20 2M	0073201	single p.	2	2650	230	50 - 60	900	16,4	160	65	0,3 -	IP44	59	2,6
AXIA TT 20 4M	0073202	single p.	4	1400	230	50 - 60	500	8,2	80	40	0,3 -	IP44	45	2,5
AXIA TT 25 4M	0073204	single p.	4	1400	230	50 - 60	1000	10,2	100	70	0,5 -	IP44	52	3,5
AXIA TT 30 4M	0073206	single p.	4	1400	230	50 - 60	1900	12,8	125	65	0,4 -	IP44	59	4,5
AXIA TT 35 4M	0073208	single p.	4	1400	230	50 - 60	3400	13,3	130	130	0,7 -	IP44	63	6,9
AXIA TT 40 4M	0073210	single p.	4	1400	230	50 - 60	4400	16,4	160	180	0,8 -	IP44	63	8
AXIA TT 20 4T	0073203	three p.	4	1400	230/400	50 - 60	500	8,2	80	20	0,2 0,1	IP44	45	2,6
AXIA TT 25 4T	0073205	three p.	4	1400	230/400	50 - 60	1000	10,2	100	25	0,2 0,1	IP44	52	3,5
AXIA TT 30 4T	0073207	three p.	4	1400	230/400	50 - 60	1900	12,8	125	55	0,3 0,2	IP44	59	4,5
AXIA TT 35 4T	0073209	three p.	4	1400	230/400	50 - 60	3400	13,3	130	130	0,7 0,4	IP44	63	6,9
AXIA TT 40 4T	0073211	three p.	4	1400	230/400	50 - 60	4400	16,4	160	195	0,8 0,5	IP44	63	8
AXIA TT 50 4T	0073212	three p.	4	1400	400	50 - 60	9000	17,3	170	530	- 1,15	IP44	74	17
AXIA TT 60 6T	0073213	three p.	6	950	400	50 - 60	11200	12,7	125	440	- 1,07	IP44	65	22

AMBITI APPLICATIVI

Indicato per installazione prevalentemente in ambito industriale:

- Industrie
- Capannoni e magazzini
- Serre ed allevamenti
- Parcheggi
- Cucine e mense
- Impianti sportivi
- Supermercati e centri commerciali
- Locali gruppo frigo o elettrogeno
- Cabine elettriche

Adatti anche per applicazioni su macchinari dove è necessaria una ventilazione o aspirazione forzata.

ENVIRONMENTS APPLICATION

Suitable for installation in industrial environment such as:

- Industries
- Sheds and Warehouses
- Greenhouses and breeding
- Parking
- Kitchens and Refectories
- Sports facilities
- Supermarkets and Shopping centers
- Cooling power plants
- Electrical generator rooms

Also suitable for application on machines where a forced ventilation or air suction is required.

GRAFICI DI PORTATA – FLOW CHARTS

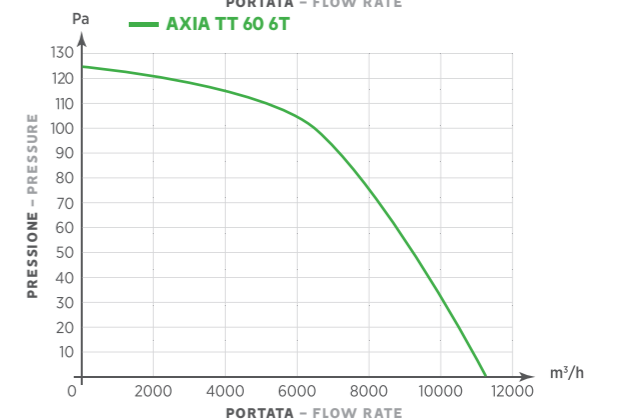
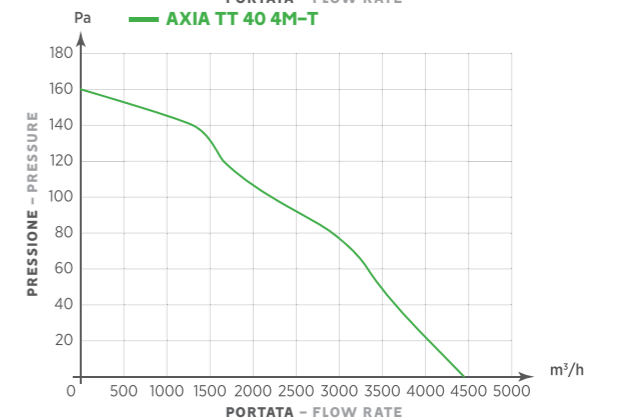
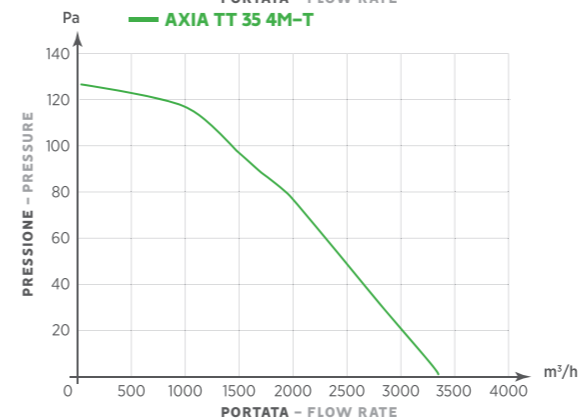
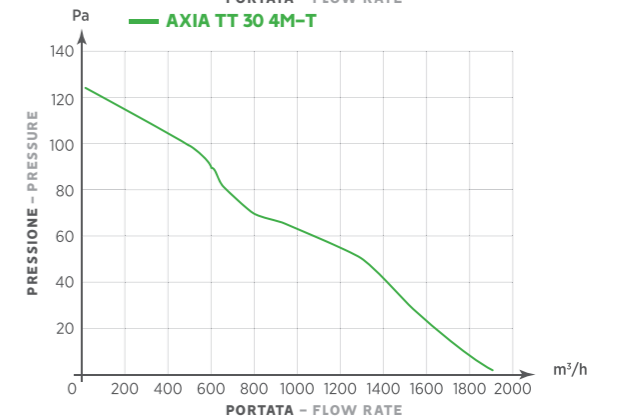
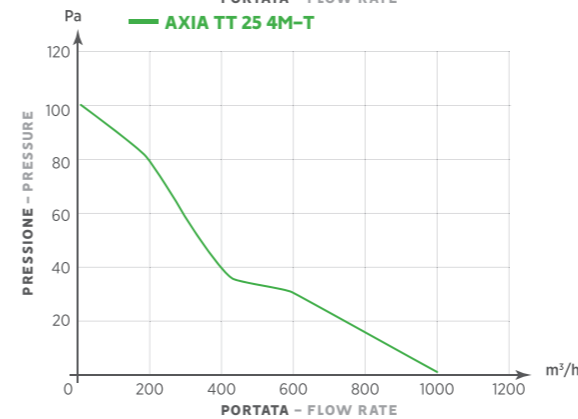
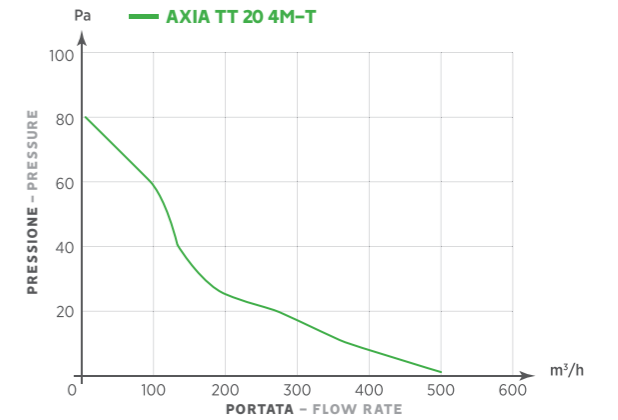
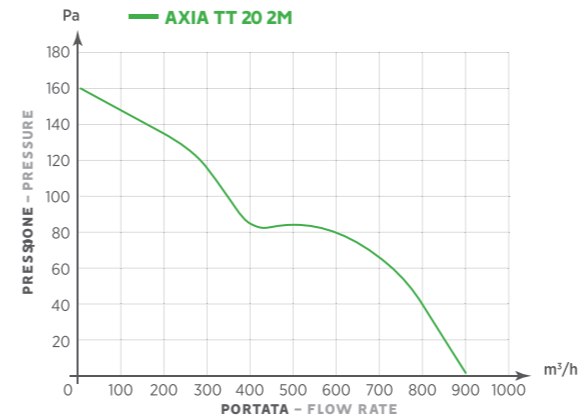

ACCESSORI (PAGINA 72, 74) – ACCESSORIES (PAGE 72, 74)



Regolatori
Controllers



Serranda a gravità
Gravity Shutter



Griglie di protezione
Protection Grill



Distanziale
Spacer

AXIA TT ECO – techno type

ASPIRATORE ASSIALE – AXIAL FAN

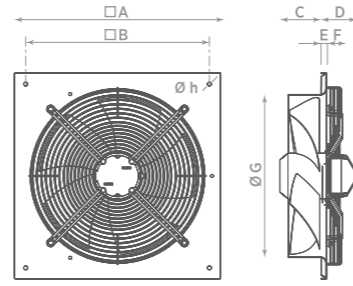

MODELLO MODEL	A	B	C	D	E	F	ØG	Øh
TT ECO 25	340	325	66	64	8	4	259	8.3
TT ECO 30	390	375	75	97	10	57	311	8.3
TT ECO 35	460	439	91	100	12	40	363	12.3
TT ECO 40	510	490	85	99	12	66	413	12.3
TT ECO 50	630	610	101	152	15	93	513	12.3
TT ECO 60	851	781	125	98	15	40	640	12.3



Aspiratori elicoidali ad elevate prestazioni con motore a commutazione elettronica. Applicazione a parete o pannello per convogliare aria o esalazioni direttamente all'esterno o in brevi condotti.

- Aspiratori compatti con ingombri limitati;
- Temperatura max dell'aria aspirata: 60°C;
- Equipaggiati con motore a commutazione elettronica ad alta efficienza per garantire alte prestazioni e consumi ridotti.
- Griglia anti-infortunistica;
- Corpo e griglia di protezione in acciaio verniciato a forno con polveri epossidiche anti corrosione;
- Motoventola a rotore esterno con ventola in materiale plastico, equilibrata staticamente e dinamicamente;
- Prodotto di lunga durata grazie all'utilizzo di un motore montato su cuscinetti a sfera, con isolamento in classe B e grado di protezione IP54;
- La velocità di rotazione del motore può essere regolata tramite il regolatore RGM 10 fornito col prodotto (oppure tramite il regolatore RG10 disponibile come accessorio);
- Conforme alle direttive comunitarie vigenti ed alle Norme: UNI EN ISO 13857; UNI EN ISO 12499; CEI EN 60204-1.
- POSIZIONAMENTO:** a muro

Axial fans high performances with high tech EC motor, wall or panel mounting to convey air or fumes directly outside or through short duct.

- Compact fans with reduced overall dimensions;
- Max temperature of extracted air: 60°C;
- Low sound level compared with high performance;
- Safety protection grille;
- Body in steel protected by an epoxy-based anticorrosive paint;
- Motor impeller with external rotor, statically and dynamically balanced, impeller in plastic PP material;
- Ball bearing class B insulation motor, IP54 protected;
- Motor speed can be regulated through RGM 10 controller, included (or through RG 10 controller, available as accessory);
- In accordance with the essential requirements of 2006/42/EC Directive concerning machines and European Standards UNI EN ISO 13857; UNI EN ISO 12499; CEI EN 60204-1.
- POSITIONING:** wall mounting.

DATI TECNICI – TECHNICAL DATA

MODELLO MODEL	CODICE CODE	MOTORE MOTOR	GIRI AL MINUTO REV. MINUTE (RPM)	TENSIONE VOLTAGE (Volt)	FREQUENZA FREQUENCY (Hz)	PORT. MAX FLOW RATE (m³/h)	PRESS. MAX MAX PRESS. (mm H ₂ O)	PRESS. MAX MAX PRESS. (Pa)	POTENZA POWER (W)	CORR. NOM. 230V	IP MOTORE IP MOTOR	RUMOROSITÀ NOISE dB(A) _{1m}	PESO WEIGHT (kg)
AXIA TT ECO 25M	0073214	single p.	2400	230	50 – 60	1500	22,4	220	50	0,45	IP54	47	3,2
AXIA TT ECO 30M	0073215	single p.	1600	230	50 – 60	2200	9,2	90	65	0,5	IP54	46	3,9
AXIA TT ECO 35M	0073216	single p.	1200	230	50 – 60	2900	7,1	70	75	0,6	IP54	48	5,5
AXIA TT ECO 40M	0073217	single p.	1100	230	50 – 60	4100	8,2	80	80	0,5	IP54	51	6,5
AXIA TT ECO 50M	0073218	single p.	1100	230	50 – 60	7100	11,2	110	280	1,8	IP54	52	11,5
AXIA TT ECO 60M	0073219	single p.	800	230	50 – 60	8900	8,7	85	240	1,1	IP54	47	15,5

AMBITI APPLICATIVI

- Indicatore per installazione prevalentemente in ambito industriale
- Industrie
 - Capannoni e Magazzini
 - Serre e Allevamenti
 - Parcheggi
 - Cucine e Mense
 - Impianti sportivi
 - Supermercati e Centri Commerciali
 - Cabine elettriche
 - Locali gruppo frigo o elettrogeno
- Adatti anche per applicazioni su macchinari dove è necessaria una ventilazione o aspirazione forzata.

ENVIRONMENTS APPLICATION

- Suitable for installation in industrial environment such as:
- Industries
 - Sheds and Warehouses
 - Greenhouse and Breeding
 - Parking
 - Kitchen and Refectories
 - Sports facilities
 - Electrical generator rooms
 - Electrical cabinets
 - Supermarkets and Shopping centers
- Also suitable for application on machines where a forced ventilation or air suction is required.

GRAFICI DI PORTATA – FLOW CHARTS

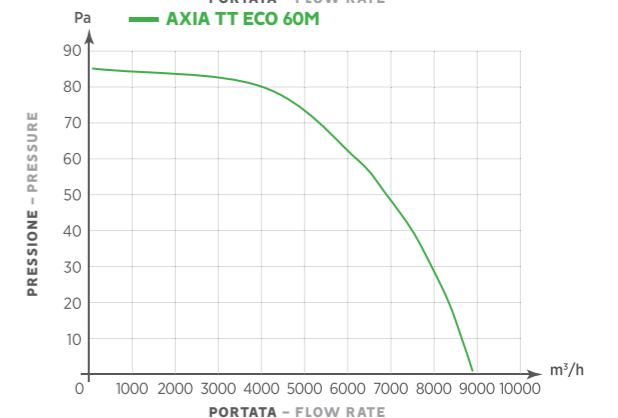
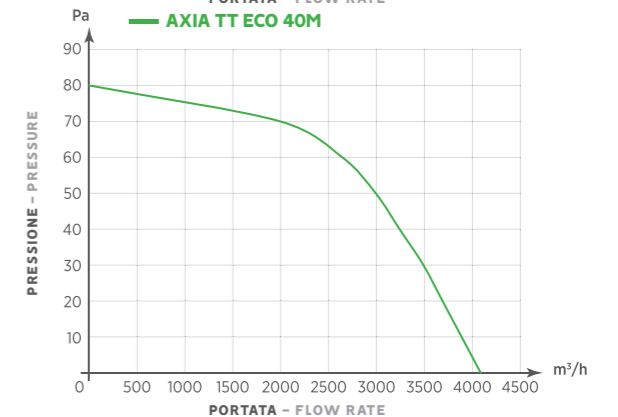
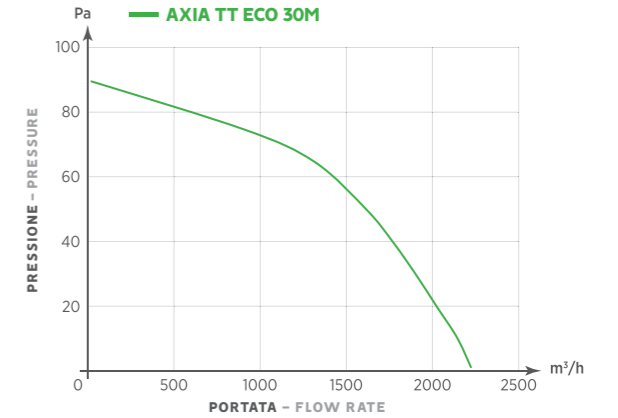
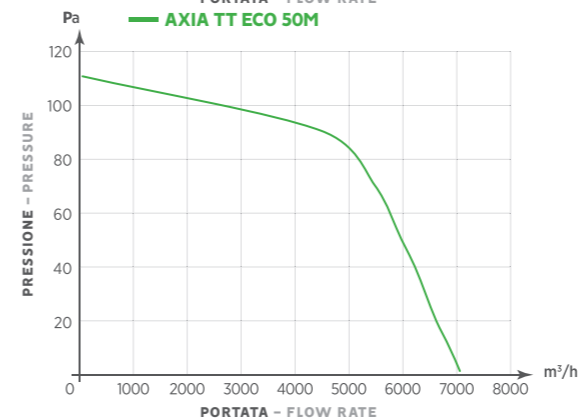
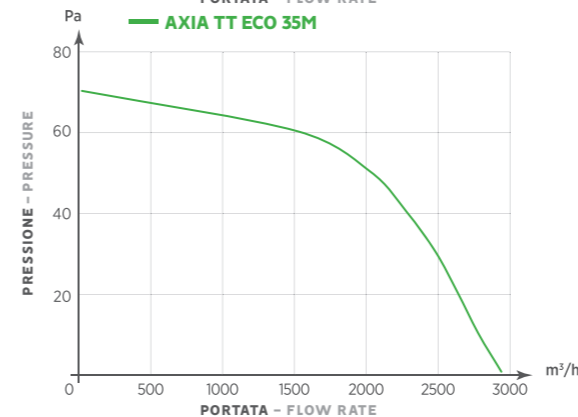
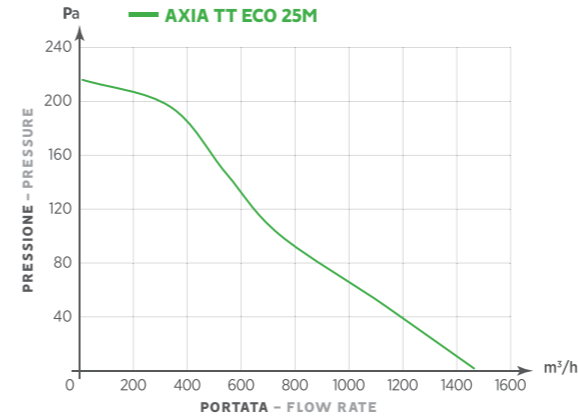

ACCESSORI (PAGINA 72, 74) – ACCESSORIES (PAGE 72, 74)



Regolatori
Controllers



Serranda a gravità
Gravity Shutter



Griglie di protezione
Protection Grill



Distanziale
Spacer

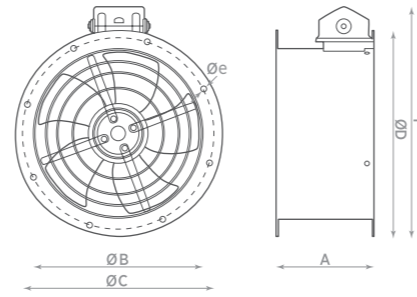

MODELLO MODEL	A	ØB	ØC	ØD	Øe	F	FORI HOLES
AXIA AI 25	160	258	280	308	10	352	4 x 90°
AXIA AI 30	180	310	355	382	10	425	8 x 45°
AXIA AI 35	180	360	395	422	10	471	8 x 45°
AXIA AI 40	190	408	450	480	12	524	8 x 45°
AXIA AI 45	220	452	500	530	12	572	8 x 45°
AXIA AI 50	220	505	560	590	12	628	12 x 30°
AXIA AI 60	220	636	690	720	12	760	12 x 30°



CE

Aspiratori assiali intubati per convogliare all'esterno aria o esalazioni provenienti da condotti.

- Anello doppia flangia
- Aspiratori compatti con ingombri limitati;
- Bassa rumorosità in rapporto alle elevate prestazioni;
- Temperatura max aria aspirata: 60°C;
- Corpo e griglia in acciaio verniciato a forno con polveri epossidiche anti corrosione;
- Ventola in lamiera d'acciaio verniciato o in materiale plastico, equilibrata staticamente e dinamicamente.
- Prodotto di lunga durata grazie all'utilizzo di un motore ad induzione a rotore esterno montato su cuscinetti a sfera, isolamento in classe B o F;
- Reversibilità: tutti tranne il modello 25 4M;
- Flange di raccordo conformi alla NORMA ISO 13351;
- Velocità regolabile tramite i regolatori industriali (opzionali);
- Conforme alle direttive comunitarie vigenti ed alle Norme UNI EN ISO 13857; UNI EN ISO 12499; CEI EN 60204 - 1.
- **POSIZIONAMENTO:** a condotto

Axial duct fans to convey air outside or fumes coming from ducts.

- Double ring flange;
- Compact fans with reduced overall dimensions;
- Low sound level compared with high performance;
- Max temperature of extracted air: 60°C;
- Body in steel protected by an epoxy-based anticorrosive paint;
- Impeller in steel protected by an epoxy-based anticorrosive paint or in plastic PP material;
- Motor impeller with external rotor mounted on ball bearing, insulation Class B or F;
- Reversibility: Three-phase: all models; Single-phase: all models except AXIA AI 25 4M;
- Flange in accordance with ISO 13351;
- Motor speed can be regulated through industrial controllers (see accessories);
- In accordance with the essential requirements of 2006/42/EC Directive concerning machines and European Standards UNI EN ISO 13857; UNI EN ISO 12499; CEI EN 60204-1.
- **POSITIONING:** Duct mounting.

DATI TECNICI - TECHNICAL DATA

MODELLO MODEL	CODICE CODE	MOTORE MOTOR	Giri al minuto Rev./minute (RPM)	TENSIONE VOLTAGE (Volt)	FREQUENZA FREQUENCY (Hz)	PORT. MAX FLOW RATE (m³/h)	PRESS. MAX MAX PRESS. (mm H ₂ O)	PRESS. MAX MAX PRESS. (Pa)	POTENZA POWER (W)	CORR. NOM. NOM. CURR. 230V 400V	IP MOTORE IP MOTOR	RUMOROSITÀ NOISE dB(A) _{1m}	PESO WEIGHT (Kg)
AXIA AI 25 2M	0073400	single p.	2500	230	50 - 60	1650	29,6	290	110	0,5 -	IP44	66	4,5
AXIA AI 25 4M	0073405	single p.	1400	230	50 - 60	1000	10,2	100	70	0,5 -	IP44	52	4
AXIA AI 30 2M	0073410	single p.	2650	230	50 - 60	3300	28,6	280	230	1,1 -	IP44	70	7
AXIA AI 30 4M	0073415	single p.	1350	230	50 - 60	1800	12,8	125	70	0,3 -	IP44	49	6
AXIA AI 35 4M	0073420	single p.	1350	230	50 - 60	3300	16,3	160	165	0,7 -	IP44	55	7
AXIA AI 40 4M	0073430	single p.	1400	230	50 - 60	4250	20,4	200	170	0,8 -	IP44	62	10
AXIA AI 45 4M	0073440	single p.	1300	230	50 - 60	7000	20,4	200	400	2,4 -	IP44	57	12
AXIA AI 25 2T	0073401	three p.	2500	400	50 - 60	1650	29,6	290	110	0,35 0,2	IP44	66	4
AXIA AI 25 4T	0073406	three p.	1400	400	50 - 60	1000	10,2	100	25	0,2 0,1	IP44	52	4,1
AXIA AI 30 2T	0073411	three p.	2600	400	50 - 60	3300	28,6	280	200	1 0,6	IP44	70	7
AXIA AI 30 4T	0073416	three p.	1350	400	50 - 60	1800	12,8	125	65	0,25 0,14	IP44	46	6
AXIA AI 35 4T	0073421	three p.	1400	400	50 - 60	3300	16,3	160	170	0,7 0,4	IP44	55	7
AXIA AI 40 4T	0073431	three p.	1400	400	50 - 60	4200	20,4	200	140	0,8 0,5	IP44	62	10
AXIA AI 45 4T	0073441	three p.	1300	400	50 - 60	7000	20,4	200	450	1,8 1	IP44	58	12
AXIA AI 50 4T	0073450	three p.	1400	400	50 - 60	9000	23,5	230	550	2,2 1,2	IP44	62	20
AXIA AI 60 6T	0073455	three p.	900	400	50 - 60	11300	15,3	150	450	1,9 1,1	IP44	58	25

AMBITI APPLICATIVI

Indicato per installazione prevalentemente in ambito industriale:

- Industrie
- Capannoni
- Magazzini
- Serre ed allevamenti
- Parcheggi
- Cucine e mense
- Impianti sportivi
- Supermercati e centri commerciali

ENVIRONMENTS APPLICATION

Suitable for installation in industrial environment such as:

- Industries
- Sheds
- Warehouses
- Greenhouses and breeding
- Parking
- Kitchens and Refectories
- Sports facilities
- Supermarkets and Shopping centers

GRAFICI DI PORTATA - FLOW CHARTS

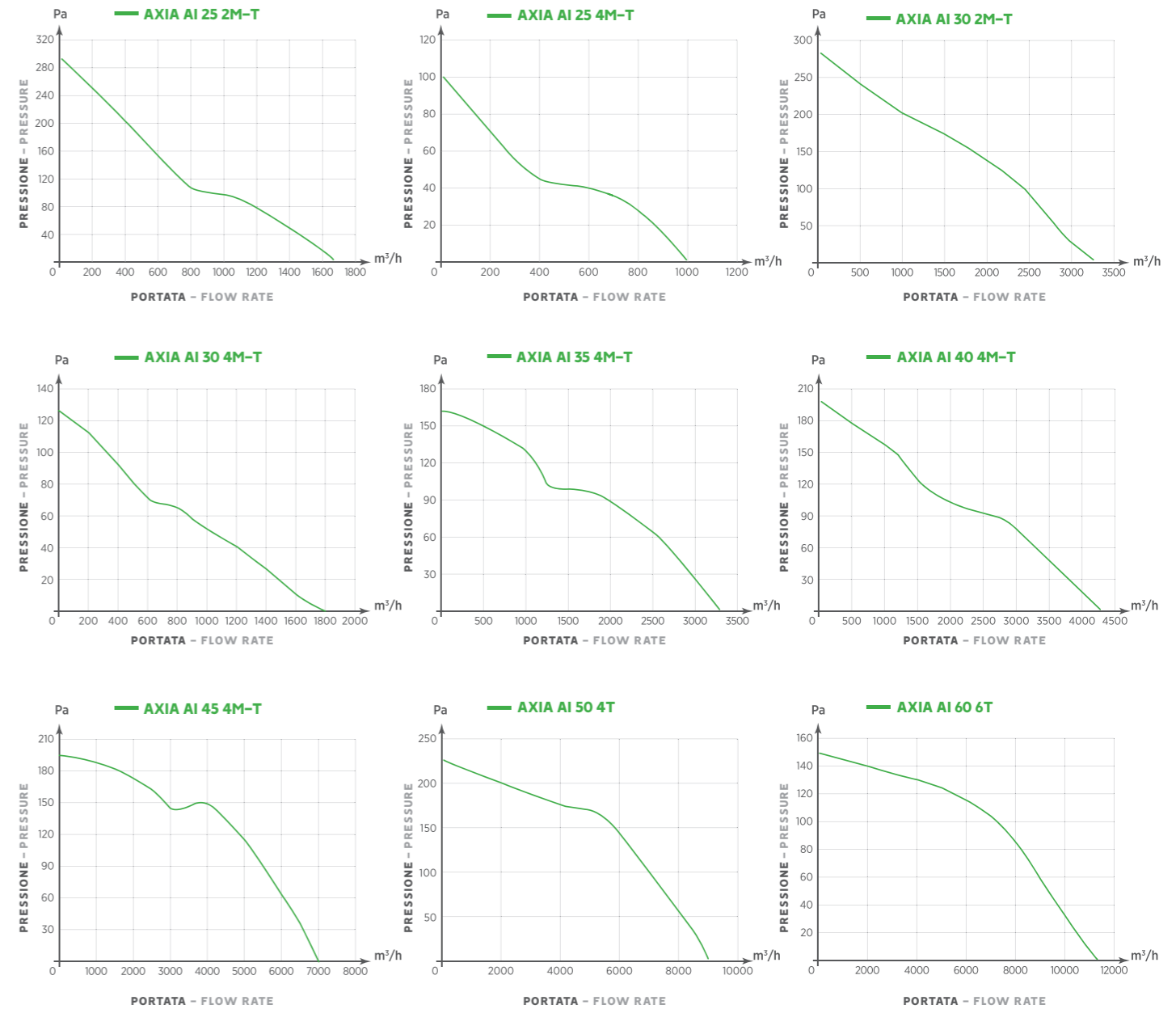

ACCESSORI (PAGINA 72, 74) - ACCESSORIES (PAGE 72, 74)



Regolatori
Controllers



Rete piana
Safety protection grille



Flangia Piana
Connection flange



Anello di prolunga
Extension ring



Giunto antivibrazione
Flexible connecton



Supporto
Support

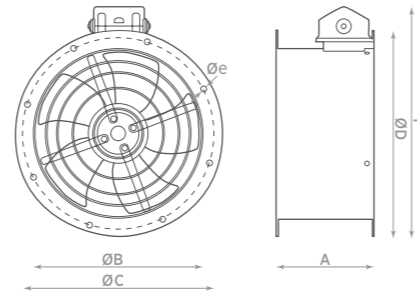

MODELLO MODEL	A	ØB	ØC	ØD	ØE	F	FORI HOLES
AXIA AI ECO 25	160	258	280	308	10	352	4 x 90°
AXIA AI ECO 30	180	310	355	382	10	425	8 x 45°
AXIA AI ECO 35	180	360	395	422	10	471	8 x 45°
AXIA AI ECO 40	190	408	450	480	12	524	8 x 45°
AXIA AI ECO 45	220	452	500	530	12	572	8 x 45°
AXIA AI ECO 50	220	505	560	590	12	628	12 x 30°
AXIA AI ECO 60	220	636	690	720	12	760	12 x 30°



CE

Aspiratori assiali intubati ad elevate prestazioni con motore a commutazione elettronica per convogliare all'esterno aria o esalazioni provenienti da condotti.

- Anello doppia flangia
- Aspiratori compatti con ingombri limitati;
- Temperatura max dell'aria aspirata: 60°C;
- Bassa rumorosità in rapporto alle elevate prestazioni;
- Corpo e griglia in acciaio verniciato a forno con polveri epossidiche anti corrosione;
- Motoventola a rotore esterno con ventola in materiale plastico, equilibrata staticamente e dinamicamente;
- Prodotto di lunga durata grazie all'utilizzo di un motore montato su cuscinetti a sfera, con isolamento in classe B e grado di protezione IP54;
- Flange di raccordo conformi alla NORMA ISO 13351;
- La velocità di rotazione del motore può essere regolata tramite il regolatore RGM 10 fornito col prodotto (oppure tramite il regolatore RG10 disponibile come accessorio);
- Conforme alle direttive comunitarie vigenti ed alle Norme: UNI EN ISO 13857; UNI EN ISO 12499; CEI EN 60204-1.
- **POSIZIONAMENTO:** a condotto

Axial duct fans, high performances with EC brushless motor to convey air outside or fumes coming from ducts.

- Double ring flange;
- Compact fans with reduced overall dimensions;
- Low sound level compared with high performance;
- Max temperature of extracted air: 60°C;
- Body and grille in steel protected by an epoxy-based anticorrosive paint;
- Motor impeller with external rotor mounted on ball bearing, insulation Class B and IP54 protected;
- Impeller in plastic material, statically and dynamically balanced;
- Flange in accordance with ISO 13351;
- Motor speed can be regulated through RGM 10 controller, included (orthrough RG 10 controller, available as accessory);
- In accordance with the essential requirements of 2006/42/EC Directive concerning machines and European Standards UNI EN ISO 13857; UNI EN ISO 12499; CEI EN 60204-1.
- **POSITIONING:** Duct mounting.

DATI TECNICI - TECHNICAL DATA

MODELLO MODEL	CODICE CODE	MOTORE MOTOR	GIRI AL MINUTO REV./MINUTE	TENSIONE VOLTAGE	FREQUENZA FREQUENCY	PORT. MAX FLOW RATE	PRESS. MAX MAX PRESS.	PRESS. MAX MAX PRESS.	POTENZA POWER	CORR. NOM NOM. CURR.	RUMOROSITÀ NOISE	PESO WEIGHT
			(RPM)	(Volt)	(Hz)	(m³/h)	(mmHg)	(Pa)	(W)	230V	dB(A) _{1m}	(Kg)
AXIA AI ECO 25 M	0073460	single p.	2400	230	50 - 60	1650	22,4	220	50	0,45	51	4
AXIA AI ECO 30 M	0073462	single p.	1500	230	50 - 60	2200	15,3	150	70	0,5	49	4,8
AXIA AI ECO 35 M	0073464	single p.	1250	230	50 - 60	3000	10,2	100	75	0,6	51	7
AXIA AI ECO 40 M	0073466	single p.	1100	230	50 - 60	4100	14,3	140	140	1,1	56	8
AXIA AI ECO 45 M	0073468	single p.	1300	230	50 - 60	6500	28,6	280	350	2,2	59	10
AXIA AI ECO 50 M	0073470	single p.	1100	230	50 - 60	7350	16,3	160	360	2,2	54	13
AXIA AI ECO 60 M	0073472	single p.	800	230	50 - 60	9000	13,3	130	240	1,0	50	16

AMBITI APPLICATIVI

Indicatore per installazione prevalentemente in ambito industriale

- Industrie
- Capannoni
- Magazzini
- Serre e Allevamenti
- Parcheggi
- Cucine e Mense
- Impianti sportivi
- Supermercati e Centri Commerciali

ENVIRONMENTS APPLICATION

Suitable for installation in industrial environment such as:

- Industries
- Sheds
- Warehouses
- Greenhouse and Breeding
- Parking
- Kitchen and Refectories
- Sports facilities
- Supermarkets and Shopping centers

GRAFICI DI PORTATA - FLOW CHARTS

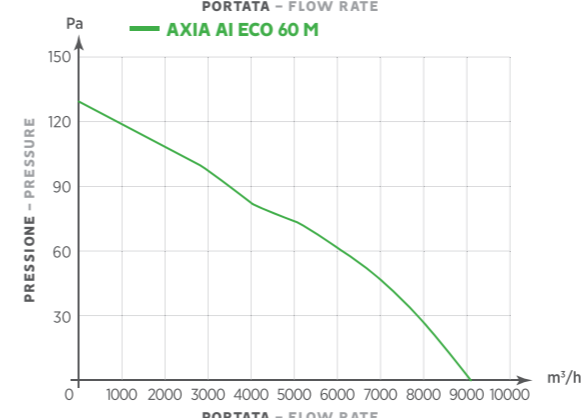
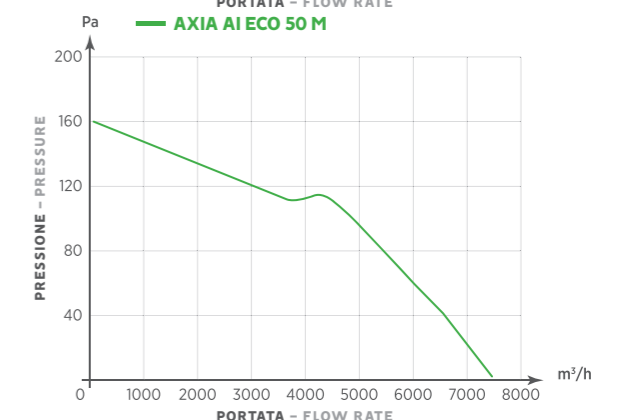
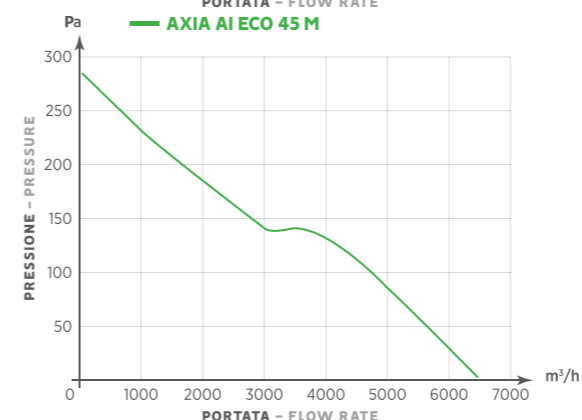
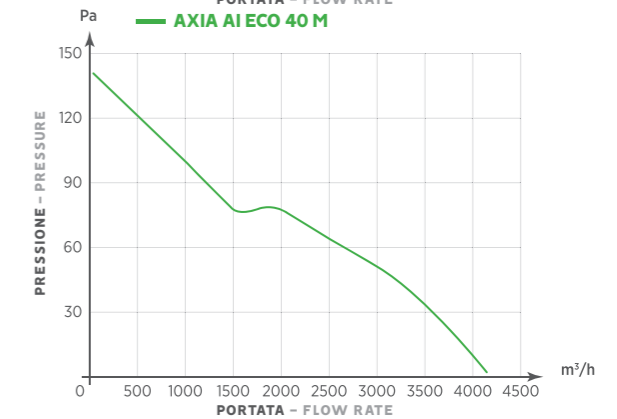
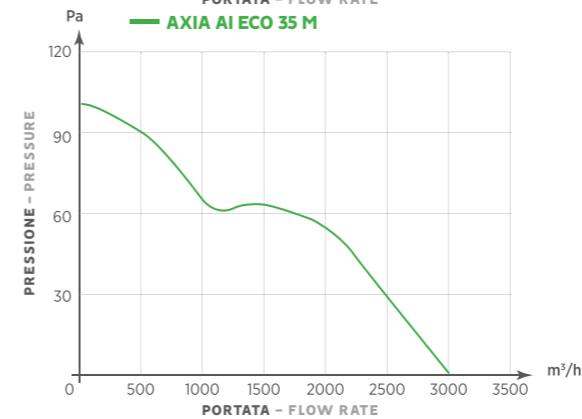
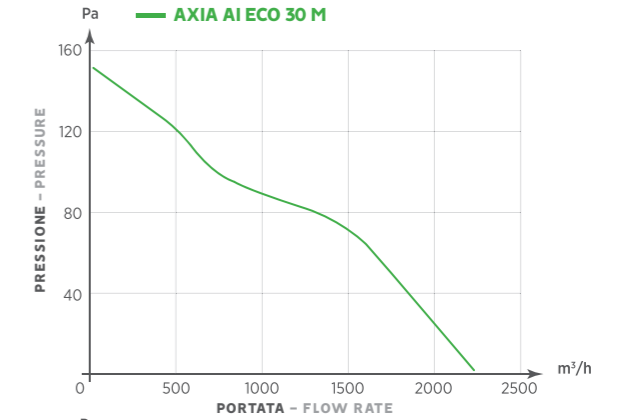
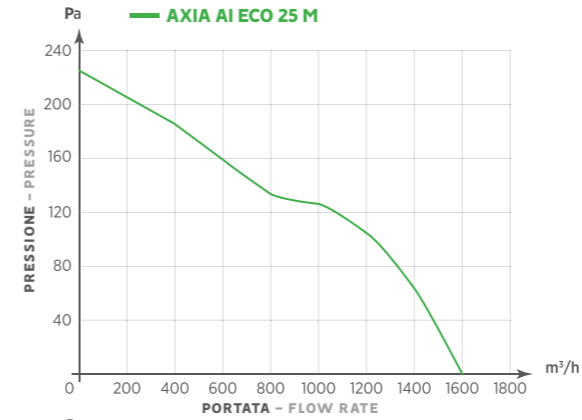

ACCESSORI (PAGINA 72, 74) - ACCESSORIES (PAGE 72, 74)



Regolatori
Controllers



Rete piana
Safety protection grille



Flangia Piana
Connection flange



Anello di prolunga
Extension ring



Giunto antivibrazione
Flexible connecton



Supporto
Support

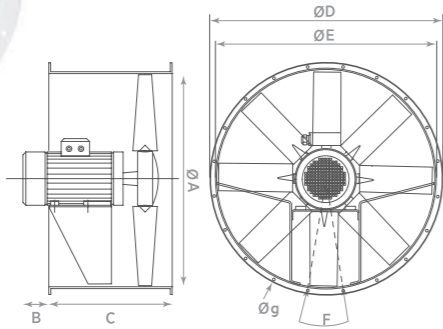

MODELLO MODEL	ØA	B	C	ØD	ØE	F	Øg
AXIA AI HP 30 2T	316,5	56	250	377	355	45°	10
AXIA AI HP 35 2T	356	40	280	421	395	45°	10
AXIA AI HP 35 4T	356	50	250	421	395	45°	10
AXIA AI HP 35 4T-P	356	50	250	421	395	45°	10
AXIA AI HP 40 4T	400	50	250	472	450	45°	12
AXIA AI HP 40 4T-P	400	50	250	472	450	45°	12
AXIA AI HP 45 4T	451	57	270	530	500	45°	12
AXIA AI HP 45 4T-P	451	57	270	530	500	45°	12
AXIA AI HP 50 4T	503	57	280	590	560	30°	12
AXIA AI HP 50 4T-P	503	57	280	590	560	30°	12
AXIA AI HP 50 6T	503	57	280	590	560	30°	12
AXIA AI HP 55 4T	559	53	330	650	620	30°	12
AXIA AI HP 55 4T-P	559	53	330	650	620	30°	12
AXIA AI HP 55 6T	559	57	280	650	620	30°	12
AXIA AI HP 60 4T	634	57	340	720	690	30°	12
AXIA AI HP 60 4T-P	634	66	340	720	690	30°	12
AXIA AI HP 60 4T-DP	634	114	360	720	690	30°	12
AXIA AI HP 60 6T	634	57	340	720	690	30°	12
AXIA AI HP 60 6T-P	634	66	340	720	690	30°	12
AXIA AI HP 70 4T	711	73	390	800	770	22,5°	12
AXIA AI HP 70 4T-P	711	115	390	800	770	22,5°	12
AXIA AI HP 70 4T-DP	711	115	390	800	770	22,5°	12
AXIA AI HP 70 6T	711	38	390	800	770	22,5°	12
AXIA AI HP 70 6T-P	711	73	390	800	770	22,5°	12
AXIA AI HP 70 8T	711	38	390	800	770	22,5°	12



Serie di ventilatori assiali intubati ad alte prestazioni, progettati per essere inseriti in impianti di ventilazione industriale e terziaria con condotte circolari normalizzate.

- Gamma composta da 8 taglie, con portate fino a 24.000 m³/h;
- Girante ad alto rendimento con pale a profilo alare, ad angolo di calettamento variabile da fermo, in tecnopolimero oppure, su richiesta, in fusione d'alluminio;
- Mozzo in fusione d'alluminio;
- Equilibratura secondo norme UNI ISO 1940;
- Tamburo in lamiera d'acciaio protetto con verniciatura epossidica;
- Flange a norma UNI ISO 6580/EUROVENT 1-2;
- Motore elettrico asincrono a corrente alternata, protezione IP 55, isolamento Cl F, servizio S1, forma B3, costruzione conforme alle specifiche norme IEC / EEC (UNELMEC);
- Taglie e prestazioni superiori sono disponibili su richiesta;
- Conforme alle direttive comunitarie vigenti ed alle Norme UNI EN ISO 13857; UNI EN ISO 12499; CEI EN 60204 - 1.
- POSIZIONAMENTO:** a condotto

High-performance ducted axial fans, designed for industrial and tertiary ventilation plants with round normalized ducts.

- The range is composed by 8 sizes, with capacities up to 24.000 m³/h;
- Impeller with high efficiency airfoil blades, variable pitch angle in still position, in plastic material or in die-cast aluminum alloy;
- Hub in die-cast aluminum alloy;
- Balancing according to UNI ISO 1940;
- Casing in steel sheet protected with epoxy painting;
- Fixing flanges according to UNI ISO 6580/EUROVENT 1-2;
- Asynchronous electric motor, protection IP 55, class F insulated, form B3, service S1 construction according to the IEC/EEC (UNEL-MEC) standard;
- Higher sizes and performance are available on request;
- POSITIONING:** Duct mounting

DATI TECNICI - TECHNICAL DATA

MODELLO MODEL	CODICE CODE	MOTORE MOTOR	N° POLI N° POLES	GIRI AL MINUTO REV./MINUTE (RPM)	TENSIONE VOLTAGE (Volt)	FREQUENZA FREQUENCY (Hz)	PORT. MAX FLOW RATE (m ³ /h)	PRESS. MAX MAX PRESS. (mm H ₂ O)	PRESS. MAX MAX PRESS. (Pa)	POTENZA POWER (W)	CORR. NOM. NOM. CORR. 400V	IP MOTORE IP MOTOR	RUMOROSITÀ NOISE dB(A) _{1m}	PESO WEIGHT (kg)
AXIA AI HP 30 2T	0013101	three p.	2	2740	400	50	3480	35	345	270	0,69	IP55	64	12
AXIA AI HP 35 2T	0013105	three p.	2	2752	400	50	4700	38	370	630	1,19	IP55	67	14
AXIA AI HP 35 4T	0013107	three p.	4	1310	400	50	2980	9	90	140	0,35	IP55	49	12
AXIA AI HP 35 4T-P	0013109	three p.	4	1310	400	50	3330	8,5	85	180	0,38	IP55	50	12
AXIA AI HP 40 4T	0013113	three p.	4	1310	400	50	3380	9,5	95	140	0,34	IP55	54	13
AXIA AI HP 40 4T-P	0013115	three p.	4	1310	400	50	4530	10,5	105	230	0,51	IP55	55	13
AXIA AI HP 45 4T	0013117	three p.	4	1310	400	50	5380	11	110	260	0,61	IP55	55	17
AXIA AI HP 45 4T-P	0013119	three p.	4	1330	400	50	6850	12	115	400	0,90	IP55	57	17
AXIA AI HP 50 4T	0013121	three p.	4	1330	400	50	5650	10,5	105	240	0,59	IP55	62	20
AXIA AI HP 50 4T-P	0013123	three p.	4	1330	400	50	6850	12	115	340	0,70	IP55	54	20
AXIA AI HP 50 6T	0013125	three p.	6	850	400	50	5600	7	68	240	0,59	IP55	48	20
AXIA AI HP 55 4T	0013127	three p.	4	1390	400	50	8300	19	190	630	1,31	IP55	61	28
AXIA AI HP 55 4T-P	0013129	three p.	4	1420	400	50	10500	22	220	810	1,66	IP55	63	28
AXIA AI HP 55 6T	0013131	three p.	6	850	400	50	7200	8	80	320	0,77	IP55	51	21
AXIA AI HP 60 4T	0013135	three p.	4	1420	400	50	10750	22	220	770	1,60	IP55	66	34
AXIA AI HP 60 4T-P	0013137	three p.	4	1435	400	50	13900	24	235	1130	2,30	IP55	63	39
AXIA AI HP 60 4T-DP	0013139	three p.	4	1445	400	50	19000	27	265	2010	3,96	IP55	65	53
AXIA AI HP 60 6T	0013141	three p.	6	885	400	50	9200	10,5	105	470	1,07	IP55	56	34
AXIA AI HP 60 6T-P	0013143	three p.	6	935	400	50	14300	12	115	870	2,12	IP55	56	39
AXIA AI HP 70 4T	0013147	three p.	4	1435	400	50	15800	31	305	1480	3,05	IP55	74	50
AXIA AI HP 70 4T-P	0013149	three p.	4	1445	400	50	19900	34	335	2100	4,05	IP55	73	60
AXIA AI HP 70 4T-DP	0013151	three p.	4	1445	400	50	23800	35,5	350	2810	5,37	IP55	73	60
AXIA AI HP 70 6T	0013153	three p.	6	935	400	50	15400	14,5	145	840	2,08	IP55	63	46
AXIA AI HP 70 6T-P	0013155	three p.	6	945	400	50	19800	15	150	1280	2,73	IP55	62	50
AXIA AI HP 70 8T	0013157	three p.	8	670	400	50	11100	7,5	75	400	1,15	IP55	56	46

AMBITI APPLICATIVI

- Ventilatori della serie AXIA AI HP sono ideali per impieghi in cui necessitano grandi portate d'aria e pressioni relativamente modeste, in applicazioni con fissaggio a canalizzazioni normalizzate.
- Impianti di ventilazione e condizionamento industriale e terziario;
 - Applicazioni minerarie, navali, torri evaporative, scambiatori di calore, raffreddamento di apparecchiature elettriche, frigorifere ecc.

ENVIRONMENTS APPLICATION

- AXIA AI HP series is suitable when large air capacities with relatively low pressures are required in duct mounted applications.
- Industrial and tertiary ventilation and conditioning systems;
 - Mining and naval applications, evaporative towers, heat exchangers, cooling of electric and refrigerating equipments, etc.

GRAFICI DI PORTATA - FLOW CHARTS

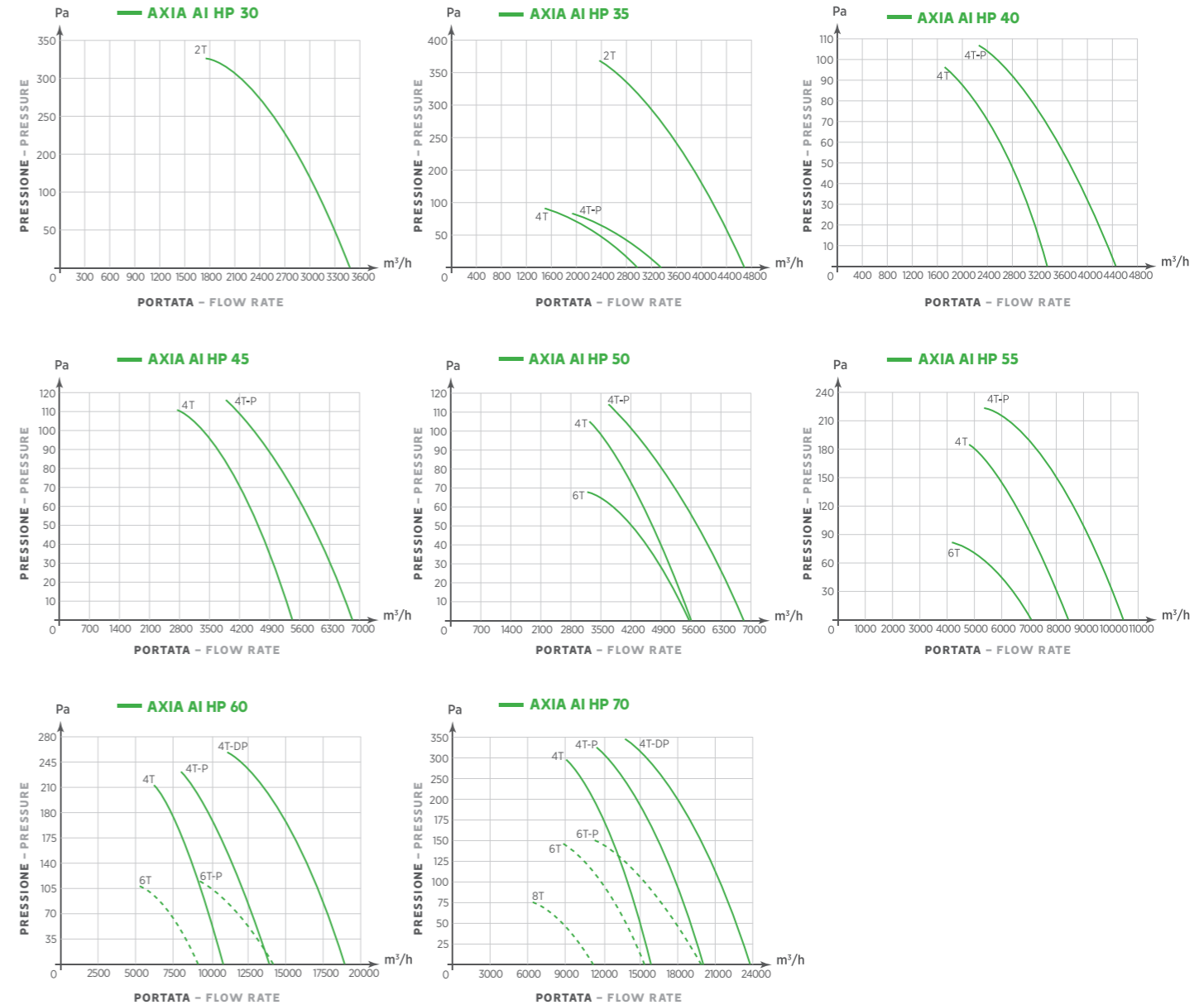

ACCESSORI (PAGINA 72, 74) - ACCESSORIES (PAGE 72, 74)



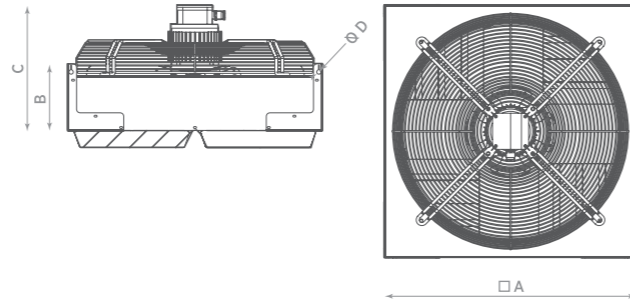

MODELLO MODEL	A	B	C	ØD
AXIA DES 450 6M	550	150	315	12
AXIA DES 600 6M	700	150	345	12
AXIA DES 710 6M	800	200	385	12



Destratificatori d'aria adatti all'installazione in ambienti con altezza superiore ai 4 metri.

- La loro funzione principale è impedire la formazione di strati d'aria a temperature diverse attraverso la miscelazione dell'aria negli ambienti dove sono installati;
- Sono composti da un ventilatore assiale monofase, dotato di ventola equilibrata in alluminio, montato su un corpo in lamiera d'acciaio verniciato provvisto di appositi anelli per il fissaggio a sospensione. La parte inferiore è dotata di alette deflettrici orientabili che consentono di direzionare il flusso d'aria secondo esigenze specifiche;
- Utilizzo invernale: l'aria calda che si accumula nella parte alta dei locali, viene convogliata nella parte bassa riscaldandola e riducendone l'umidità relativa, ciò consente un risparmio energetico con conseguente diminuzione delle spese di riscaldamento (fino al 30%);
- Utilizzo estivo: il movimento dell'aria crea raffrescamento per effetto dell'evaporazione dell'umidità corporea. L'umidità relativa ambientale al suolo viene ridotta (fino al 20%) per effetto della omogeneizzazione;
- Il termostato in dotazione consente il funzionamento automatico del destratificatore in base alla temperatura dell'aria;
- Motore asincrono monofase ad induzione con isolamento in classe F e grado di protezione IP55;
- Velocità regolabile tramite i regolatori industriali (opzionali).
- POSIZIONAMENTO:** a sospensione

Air Destratifier suitable for installation in environments where the height of the ceiling is over 4 meters.

- Their main function is to prevent the formation of air layers with different temperatures through the air blending in the environment where installed;
- Composed of single phase axial fan, equipped with an aluminium balanced impeller, mounted on body in steel material painted, supplied with specific rings to be fixed in suspension. The lower part is equipped with adjustable deflector fins in order to regulate the airflow according to specific requirements;
- On winter: the hot air accumulated on the top of the environments is conveyed in the lower area heating it and reducing the relative humidity, it contributes to energy saving with a reduction of heating expenses (up to 30%);
- On summer: the air movement creates fresh effect due to the body humidity evaporation. The relative humidity to the ground is reduced (up to 20%) due to the homogenization;
- The thermostat on the product allows to work automatically according to the air temperature;
- Ball bearing single phase class F insulation motor IP55 protected;
- Motor speed can be regulated through the industrial controllers (see accessories).
- POSITIONING:** Ceiling mounting

DATI TECNICI - TECHNICAL DATA

MODELLO MODEL	CODICE CODE	MOTORE MOTOR	N° POLI N° POLES	GIRI AL MINUTO Rev. minute (RPM)	TENSIONE VOLTAGE (volt)	FREQUENZA FREQUENCY (Hz)	PORT. MAX FLOW RATE (m³/h)	POTENZA POWER (W)	IP MOTORE IP MOTOR	CORR. NOM NOM. CURR 230V (A)	RUMOROSITÀ NOISE dB(A) _{1m}	PESO WEIGHT (kg)
AXIA DES 450 6M	0024910	single p.	6	900	230	50 - 60	3500	100	IP55	0,6	58	14
AXIA DES 600 6M	0024920	single p.	6	900	230	50 - 60	7300	470	IP55	1,5	59	24
AXIA DES 710 6M	0024930	single p.	6	900	230	50 - 60	11300	750	IP55	4	60	36

AMBITI APPLICATIVI

Indicato per installazione prevalentemente in ambito industriale:

- Industrie;
- Capannoni;
- Magazzini;
- Serre ed allevamenti;
- Impianti sportivi;
- Supermercati e centri commerciali.

ENVIRONMENTS APPLICATION

Suitable for installation in industrial environment such as:

- Industries;
- Sheds and Warehouses;
- Greenhouses and breeding;
- Sports facilities;
- Supermarkets and Shopping centers.

GRAFICI DI PORTATA - FLOW CHARTS

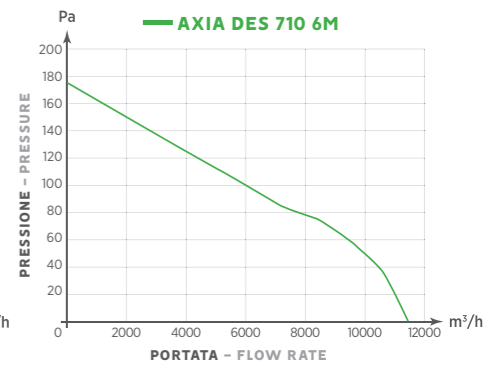
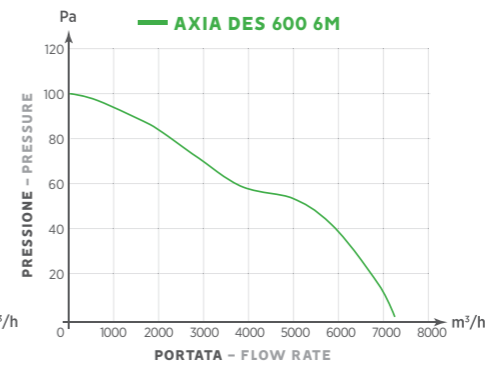
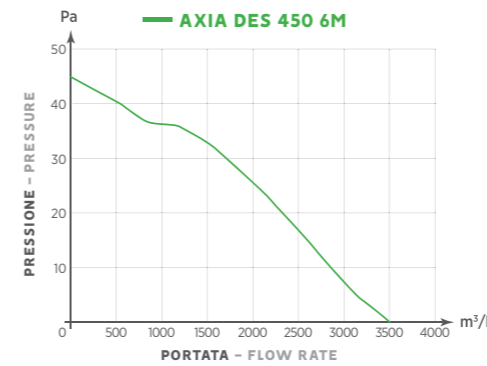

GUIDA PER LA SCELTA DEL DESTRATIFICATORE - HOW TO SELECT THE CORRECT PRODUCT

La scelta del modello deve essere eseguita tenendo conto dell'altezza del locale e dell'altezza di installazione, in quanto maggiore è l'altezza e maggiore deve essere la sua taglia. Una semplice regola per determinare il numero di destratificatori da installare consiste nel calcolare 5 ricicli d'aria/ora per mezzo della seguente formula:

$$N^{\circ} \text{ DESTRATIFICATORI} = [5 \times (\text{m}^3 \text{ AMBIENTE})] / \text{PORTATA DESTRATIFICATORE m}^3/\text{h}$$

Nella figura qui di seguito, viene riportata l'altezza massima alla quale è possibile installare i diversi modelli.

The correct model can be selected in accordance with the height of the premises and how high the destratifier needs to be installed. Higher is the destratifier installed, larger must be its size. An approximate method to define how many destratifiers must be installed in a premises consists in calculating 5 air exchanges per hour by means of the following formula:

$$N^{\circ} \text{ OF DIFFUSERS} = [5 \times (\text{m}^3 \text{ ENVIRONMENT})] / \text{DIFFUSER CAPACITY m}^3/\text{h}$$

The maximum installation height of each model as shown below.

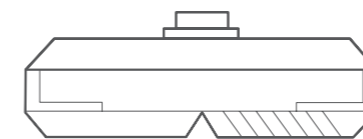

modello model 710

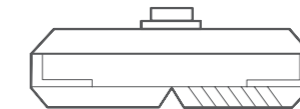

modello model 600



modello model 450

h max 24 m

h max 18 m

h max 12 m

ACCESSORI (PAGINA 72) - ACCESSORIES (PAGE 72)



Regolatori
Controllers

ASPIRATORE ELICO-CENTRIFUGO IN LINEA - IN LINE MIXED FLOW FAN

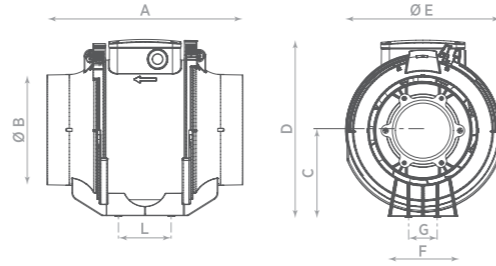

MODELLO MODEL	A	B	C	D	E	F	G	L	Ø TUBO Ø PIPE
LINEAR 100	258	97,5	102,5	210	180	92	38,5	67,5	100
LINEAR 125	258	122,5	102,5	210	180	92	38,5	67,5	125
LINEAR 150	263	147,5	115	235	205	92	38,5	67,5	150
LINEAR 160	267	157,5	115	235	205	92	38,5	67,5	160
LINEAR 200	305	194	120	260	220	130	100	90	200

CE IPX4 T 60 T 55 CB □

- Aspiratori elico-centrifugo in linea ad elevate caratteristiche per convogliare in condotti aria e fumi.
- Idoneo per installazioni in ambienti civili, commerciali e industriali;
- Temperatura max aria aspirata: 60°C (55° per Linear 200);
- Motore dotato di cuscinetti a sfera per una lunga durata;
- 3 velocità di funzionamento (2 per Linear 200);
- Facilità di installazione e manutenzione;
- Possibilità di sostituire l'unità ventilante in pochi secondi;
- Morsettiera di collegamento posta sull'unità ventilante;
- Vano collegamento elettrico con grado di protezione IP54;
- Realizzati in doppio isolamento, non necessitano di messa a terra (escluso Linear 200);
- Versione T (Timer) (escluso Linear 200);
- Sensori PIR (presenza) e HT (Umidostato e Timer) installabili come accessori (opzionali);
- Velocità regolabile mediante regolatore (opzionale);
- Conformi alla NORMA EN 60335-2-80;
- POSIZIONAMENTO:** a Condotta

- In line mixed flow duct fan, high valued features to convey air or fumes through ducts;
- Suitable for domestic, commercial and industrial environments;
- Max temperature of extracted air: 60°C (55° for Linear 200);
- Long life ball bearing motor;
- 3 running speeds (2 for Linear 200);
- Easy installation and maintenance;
- Quick release of the central unit;
- Terminal block placed on the unit;
- Electrical connection compartment IP54 protected;
- Double insulated product, without ground wire (excluding Linear 200);
- T (Timer) model option (excluding Linear 200);
- PIR (presence infra-red) and HT (Humidistat and Timer) sensors can be installed as optional accessories;
- Motor speed can be regulated through controller (optional);
- In accordance with EN 60335-2-80 Standard.
- POSITIONING:** Duct

DATI TECNICI - TECHNICAL DATA

MODELLO MODEL	CODICE CODE	MOTORE MOTOR	N° POLI N° POLES	GIRI AL MINUTO REV. PER MIN. (RPM)	TENSIONE VOLTAGE (Volt)	FREQUENZA FREQUENCY (Hz)	PORTATA MAX FLOW RATE (m³/h)	PRESS. MAX MAX PRESS. (mm H ₂ O)	PRESS. MAX MAX PRESS. (Pa)	POTENZA POWER (W)	CORR. NOM NOM. CURR. 230V (A)	IP MOTORE IP MOTOR	RUMOROSITÀ NOISE dB(A) _{1m}	PESO WEIGHT (Kg)
LINEAR 100	0047300	single p.	2	2400	220-240	50-60	260	19	186	28	0,12	IPX4	38	1,8
LINEAR 100 T	0047301	single p.	2	2400	220-240	50-60	260	19	186	28	0,12	IPX4	38	1,8
LINEAR 125	0047310	single p.	2	2150	220-240	50-60	350	17	167	29	0,13	IPX4	42	1,8
LINEAR 125 T	0047311	single p.	2	2150	220-240	50-60	350	17	167	29	0,13	IPX4	42	1,8
LINEAR 150	0047320	single p.	2	2170	220-240	50-60	500	27	265	40	0,2	IPX4	51	2,5
LINEAR 150 T	0047321	single p.	2	2170	220-240	50-60	500	27	265	40	0,2	IPX4	51	2,5
LINEAR 160	0047330	single p.	2	2170	220-240	50-60	500	27	265	40	0,2	IPX4	51	2,5
LINEAR 160 T	0047331	single p.	2	2170	220-240	50-60	500	27	265	40	0,2	IPX4	51	2,5
LINEAR 200	0047340	single p.	2	2400	220-240	50	1050	33	320	109	0,47	IPX4	40	3,2

AMBITI APPLICATIVI

- Idonei per applicazioni in ambienti civili, commerciali e industriali:
- Bagni
- Cucine
- Uffici
- Fabbriche
- Negozi
- Palestre
- Bar e ristoranti

APPLICATION

- Suitable for domestic, commercial and industrial environments:
- Bathrooms
- Kitchens
- Offices
- Factories
- Shops
- Gyms
- Cafe and restaurants

PERFORMANCE A DIVERSE VELOCITÀ - PERFORMANCE VALUES AT DIFFERENT SPEED

MODELLO MODEL	PORTATA MAX FLOW RATE (m³/h)			PRESSIONE MAX PRESSURE (mm H ₂ O)			PRESSIONE MAX PRESSURE (Pa)			GIRI AL MINUTO REV. PER MIN. (RPM)			POTENZA POWER (W)			RUMOROSITÀ NOISE dB(A) _{1m}		
	Vel./Speed	Vel./Speed	Vel./Speed	Vel./Speed	Vel./Speed	Vel./Speed	Vel./Speed	Vel./Speed	Vel./Speed	Vel./Speed	Vel./Speed	Vel./Speed	Vel./Speed	Vel./Speed	Vel./Speed	Vel./Speed	Vel./Speed	
LINEAR 100	260	190	140	19	13	11	186,4	127,5	107,9	2250	1550	1300	27	23	20	38	30	26
LINEAR 125	350	230	180	17	11	8	166,8	107,9	78,5	2000	1350	1150	29	23	20	42	33	29
LINEAR 150	500	360	300	27	17	14	264,9	166,8	137,3	2000	1400	1200	40	35	33	51	42	37
LINEAR 160	500	360	300	27	17	14	264,9	166,8	137,3	2000	1400	1200	40	35	33	51	42	37
LINEAR 200	1050	-	710	33	-	24	320	-	230	2400	-	2190	109	-	95	40	-	35

GRAFICI DI PORTATA - FLOW CHARTS

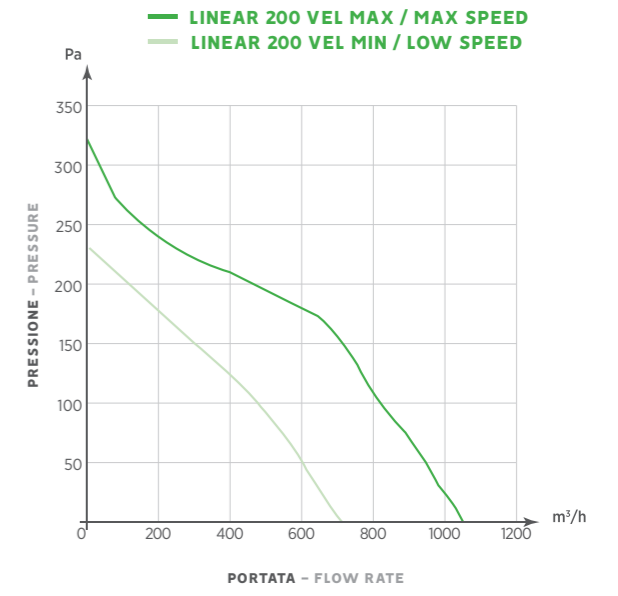
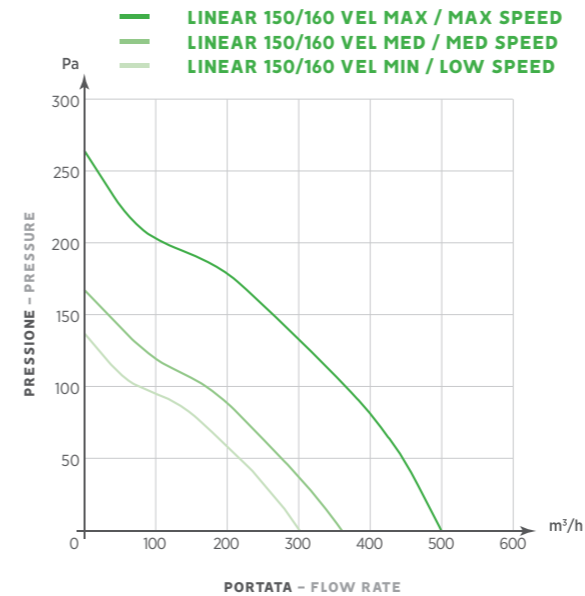
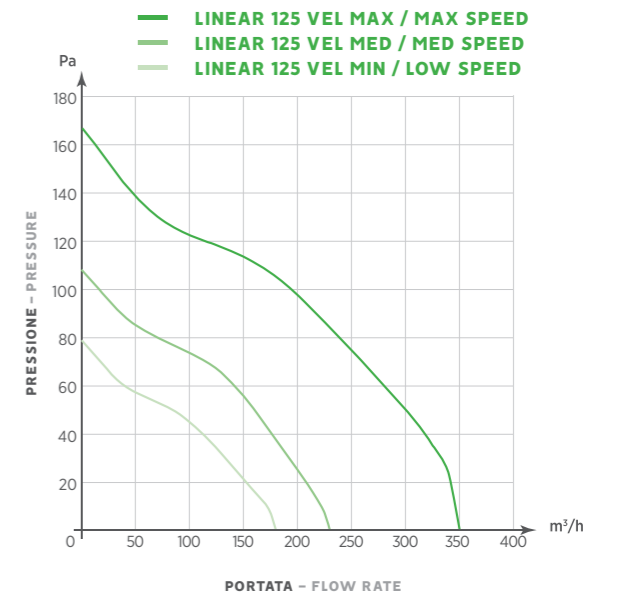
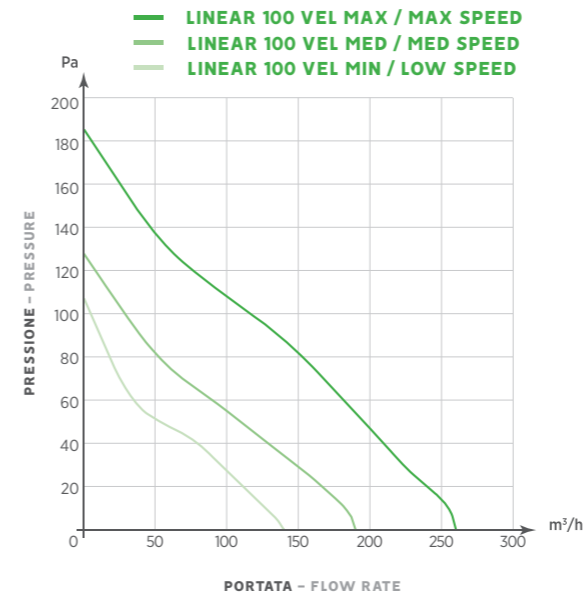

ACCESSORI (PAGINA 72, 74) - ACCESSORIES (PAGE 72, 74)



ASPIRATORE CENTRIFUGO IN LINEA - IN LINE CENTRIFUGAL FAN

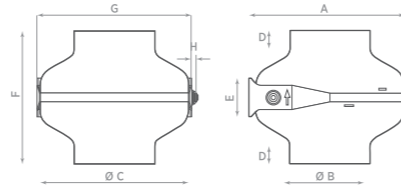

MODELLO MODEL	A	ØB	ØC	D	E	F	G	H
TURBO 100 ES	287	98	275	17	70	242	282	12
TURBO 100	287	98	275	17	70	242	282	12
TURBO 125 ES	287	123	275	24	70	242	282	12
TURBO 125	287	123	275	24	70	242	282	12
TURBO 150 ES	287	148	275	32	70	242	282	12
TURBO 150	287	148	275	32	70	242	282	12
TURBO 160 ES	287	158	275	35	70	242	282	12
TURBO 160	354	158	345	24	84	272	345	12
TURBO 200 ES	354	198	345	34	84	272	345	12
TURBO 200	354	198	345	34	84	272	345	12
TURBO 250	354	248	345	48	84	272	345	12
TURBO 315 ES	354	313	345	48	84	272	345	12
TURBO 315	354	313	345	48	84	272	345	12

CE IPX4 T 40 CB

Aspiratori centrifughi IN LINEA ad elevate caratteristiche per convogliare in condotti aria e fumi.

- Ideali per installazione in ambienti civili, commerciali e industriali;
- Temperatura max aria aspirata: 55°C;
- Disponibile nella versione ES (Energy Saving) ad elevata silenziosità e basso consumo elettrico;
- Motore dotato di cuscinetti a sfera e termoprotettore;
- Staffa di sostegno e/o fissaggio integrata nel prodotto;
- Convogliatori in acciaio zincato, supporto motore in nylon caricato in fibra di vetro ad alta resistenza dotato di raddrizzatore di flusso;
- Possibilità di montaggio in qualsiasi posizione;
- Fori nella staffa per montaggio a sospensione;
- Staffa di sostegno e/o fissaggio integrata nel prodotto;
- Grado di protezione: IPX4;
- Imbocchi di aspirazione e mandata con vari diametri adatti per tubazioni comunemente in commercio;
- La serie è in grado di offrire elevate prestazioni, anche nella versione ES, (Energy Saving) che offre elevata silenziosità abbinata ad un consumo elettrico assai ridotto aumentandone ulteriormente la durata;
- Vano collegamento elettrico con grado di protezione IP54;
- Realizzati in doppio isolamento, non necessitano di messa a terra;
- Velocità regolabile mediante regolatore (opzionale);
- Conformi alla NORMA EN 60335-2-80.
- **POSIZIONAMENTO:** a Condotto

In Line centrifugal high performances fans to convey air or fumes through ducts.

- Suitable for domestic, commercial and industrial environments;
- Max temperature of extracted air: 55°C;
- The range is composed by 13 models in standard version with high performances and in ES version with reduced noise level and energy consumption;
- Ball bearing motor protected
- Zinc plated steel frame, high resistance motor support with incorporated airflow fins;
- Integrated mounting bracket for easy and quick installation;
- Holes provided in the bracket allow mounting with cords;
- Electrical box IP54 protected;
- Product IPX4 protected;
- Double insulated product, without ground wire for fast connection;
- In accordance with EN 60335-2-80;
- Motor speed can be regulated through optional controller.
- **POSITIONING:** Duct mounting

DATI TECNICI - TECHNICAL DATA

MODELLO MODEL	CODICE CODE	MOTORE MOTOR	N° POLI N° POLES	GIRI AL MINUTO REV. PER MIN. (RPM)	TENSIONE VOLTAGE (Volt)	FREQUENZA FREQUENCY (Hz)	PORTATA MAX FLOW RATE (m³/h)	PRESS. MAX MAX PRESS (mm H₂O)	PRESS. MAX MAX PRESS (Pa)	POTENZA POWER (W)	CORR. NOM. NOM. CURR. 230V (A)	IP MOTORE IP MOTOR	RUMOROSITÀ NOISE dB(a) _{1m}	PESO WEIGHT (Kg)
TURBO 100 ES	0037100	single p.	2	2000	220-240	50	210	30	294	40	0,25	IPX4	45	2,9
TURBO 100	0037000	single p.	2	2600	220-240	50	270	30	294	60	0,35	IPX4	53	2,7
TURBO 125 ES	0037400	single p.	2	1850	220-240	50	290	29	285	40	0,25	IPX4	45	2,8
TURBO 125	0037300	single p.	2	2530	220-240	50	400	29	285	60	0,38	IPX4	52	2,8
TURBO 150 ES	0037700	single p.	2	1850	220-240	50	370	27	265	40	0,25	IPX4	42	2,7
TURBO 150	0037600	single p.	2	2530	220-240	50	500	29	285	60	0,38	IPX4	52	2,7
TURBO 160 ES	0037800	single p.	2	2500	220-240	50	540	28	275	60	0,38	IPX4	52	2,7
TURBO 160	0037900	single p.	2	2500	220-240	50/60	710	37	363	90	0,43	IPX4	56	4,5
TURBO 200 ES	0038000	single p.	2	2550	220-240	50/60	730	30	294	90	0,42	IPX4	56	4,4
TURBO 200	0038100	single p.	2	2550	220-240	50/60	1050	55	540	180	0,78	IPX4	58	5,5
TURBO 250	0038300	single p.	2	2590	220-240	50/60	1200	56	549	180	0,78	IPX4	59	5,1
TURBO 315 ES	0038500	single p.	2	2600	220-240	50/60	1250	50	490	180	0,78	IPX4	59	4,8
TURBO 315	0038400	single p.	2	2500	220-240	50/60	1400	65	638	280	1,24	IPX4	59	5,5

AMBITI APPLICATIVI

- Ideali per applicazioni in ambienti civili, commerciali e industriali:
- Bagni
- Cucine
- Uffici
- Fabbriche
- Negozi
- Palestre
- Bar e ristoranti

ENVIRONMENTS APPLICATION

- Suitable for domestic, commercial and industrial environment such as:
- Bathroom;
- Kitchens;
- Offices;
- Factories;
- Shops;
- Gymnasiums;
- Bars & Restaurants

GRAFICI DI PORTATA - FLOW CHARTS

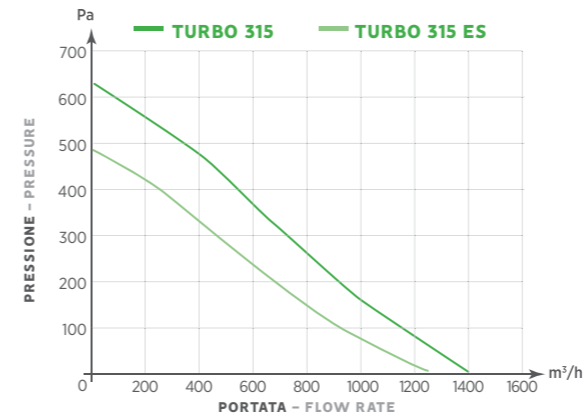
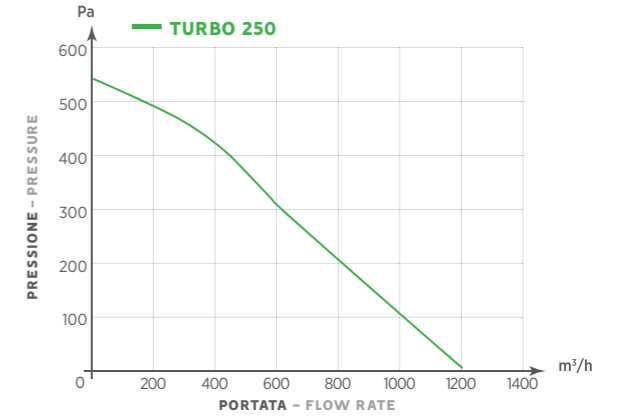
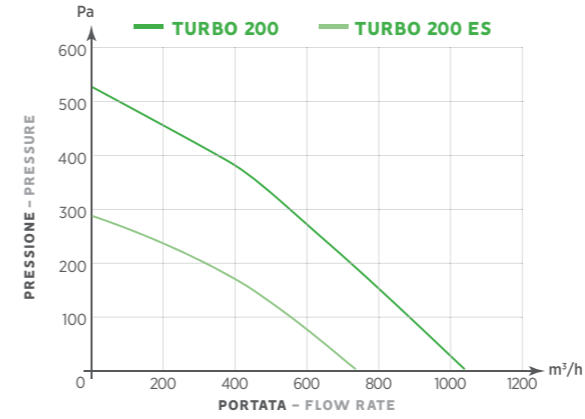
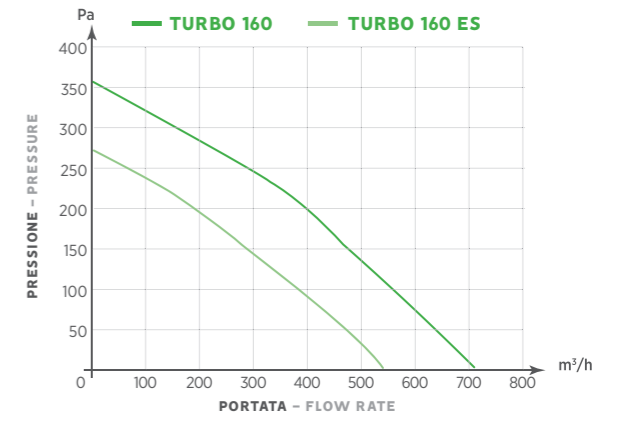
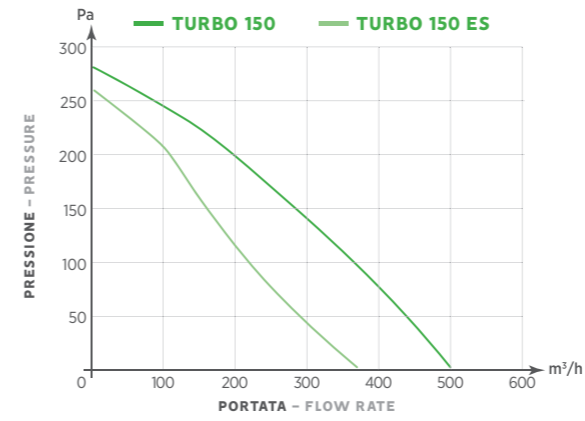
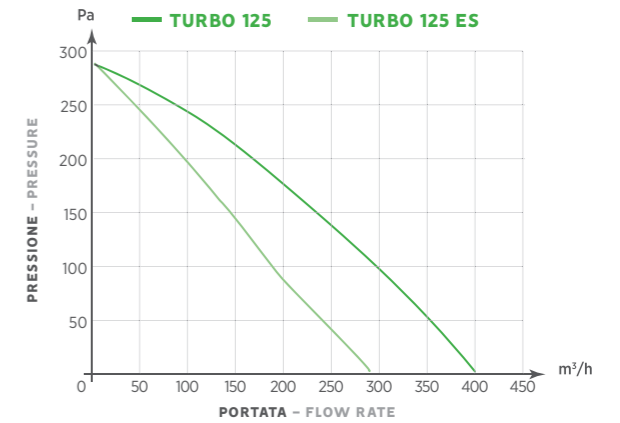
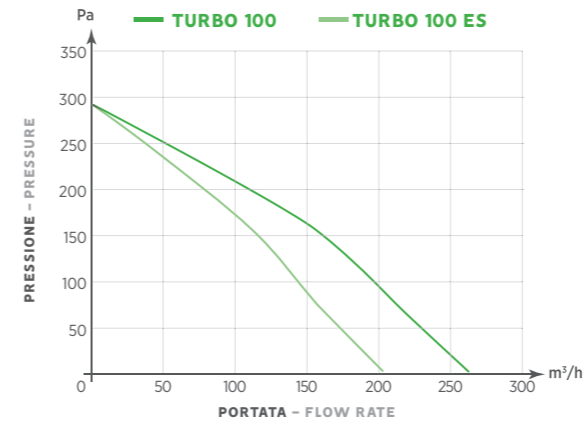

ACCESSORI (PAGINA 72, 74) - ACCESSORIES (PAGE 72, 74)



Regolatori
Controllers



Fascetta stringitubo
Duct clamp



Griglia di protezione
Protection grille



Serranda antiritorno
Backdraught shutter

ASPIRATORE CENTRIFUGO IN LINEA – IN LINE CENTRIFUGAL FAN

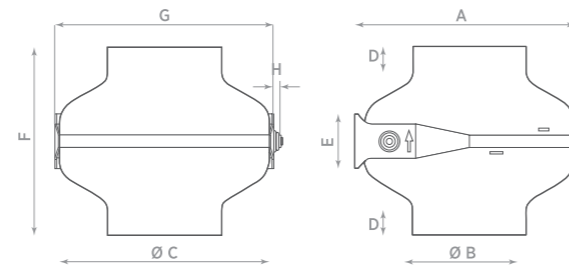

MODELLO MODEL	A	ØB	ØC	D	E	F	G	H
TURBOPLAST 100	287	98	275	17	70	242	282	12
TURBOPLAST 125	287	123	275	24	70	242	282	12
TURBOPLAST 150	287	148	275	32	70	242	282	12
TURBOPLAST 160	287	158	275	33	70	242	282	12

CE IPX4 T 40 □ CB



Aspiratori centrifughi IN LINEA ad elevate caratteristiche per convogliare in condotti aria e fumi.

- Idonei per installazione in ambienti civili, commerciali e industriali;
- Temperatura max aria aspirata: 55°C;
- Struttura realizzata in polimero VO;
- Motore dotato di cuscinetti a sfera e termoprotettore;
- Staffa di sostegno e/o fissaggio integrata nel prodotto;
- Possibilità di montaggio in qualsiasi posizione;
- Fori nella staffa per montaggio a sospensione;
- Grado di protezione: IPX4;
- Vano collegamento elettrico con grado di protezione IP54;
- Sono dotati di griglia di sicurezza incorporata sia sulla bocca di aspirazione che su quella di mandata;
- Nel caso di installazione a condotto è possibile rimuovere facilmente la griglia di protezione dal lato intubato, aumentando così la portata del prodotto (vedi grafici);
- Realizzati in doppio isolamento non necessitano della messa a terra;
- Velocità regolabile mediante regolatore (opzionale);
- Conformi alla NORMA EN 60335-2-80.
- **POSIZIONAMENTO:** a Condotto

In Line centrifugal high performances fans to convey air or fumes through ducts.

- Suitable for domestic, commercial and industrial environments;
- Max temperature of extracted air: 55°C;
- Frame completely made of VO polymeric material;
- High resistance motor support with incorporated air fins;
- Integrated mounting bracket for easy and quick installation;
- Holes provided in the bracket allow mounting with cords;
- Electrical box IP54 protected;
- Product IPX4 protected;
- Provided with incorporated safety grilles both on inlet and outlet openings, that can be easily removed for duct installation to increase product's airflow (see table below);
- Double insulated product, without ground wire for fast connection;
- Motor speed can be regulated through optional controller;
- In accordance with EN 60335-2-80;
- **POSITIONING:** Duct mounting

DATI TECNICI – TECHNICAL DATA

MODELLO	CODICE	MOTORE	N° POLI	GIRI AL MINUTO	TENSIONE	FREQUENZA	PORTATA MAX 1 GRIGLIA 2 GRIGLIE	PRESS. MAX	PRESS. MAX	POTENZA	CORR. NOM.	IP MOTORE	RUMOROSITÀ	PESO
MODEL	CODE	MOTOR	N° POLES	REV. PER MIN.	VOLTAGE	FREQUENZA	FLOW RATE 1 GRILLE 2 GRILLES	MAX PRESS	MAX PRESS	POWER	NOM. CURR.	IP MOTOR	NOISE	WEIGHT
				(RPM)	(Volt)	(Hz)	(m³/h)	(mm H ₂ O)	(Pa)	(W)	230V (A)		dB(A) _m	(Kg)
TURBOPLAST 100	0037200	single p.	2	2680	220-240	50	250 220	31	304	60	0,3	IPX4	48	2
TURBOPLAST 125	0037500	single p.	2	2560	220-240	50	370 310	30	294	60	0,33	IPX4	48	2
TURBOPLAST 150	0038600	single p.	2	2450	220-240	50	460 400	29	285	60	0,39	IPX4	49	2,2
TURBOPLAST 160	0038700	single p.	2	2450	220-240	50	500 450	29	285	60	0,3	IPX4	50	2,2

AMBITI APPLICATIVI

Idonei per applicazioni in ambienti civili, commerciali e industriali:

- Bagni
- Cucine
- Uffici
- Fabbriche
- Negozi
- Palestre
- Bar e ristoranti

ENVIRONMENTS APPLICATION

Suitable for Domestic, Commercial and industrial environment such as:

- Bathroom;
- Kitchens;
- Offices;
- Factories;
- Shops;
- Gymnasiums;
- Bars & Restaurants

GRAFICI DI PORTATA – FLOW CHARTS

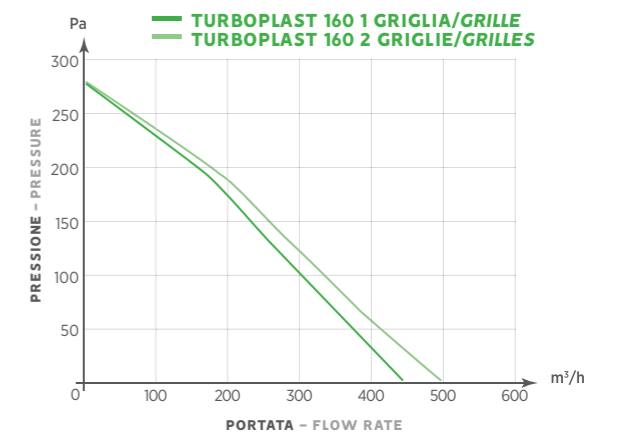
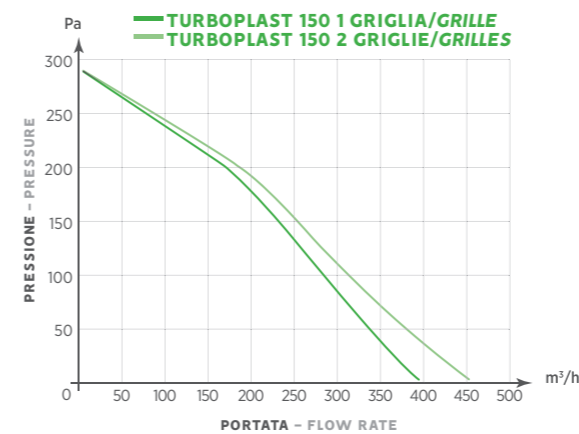
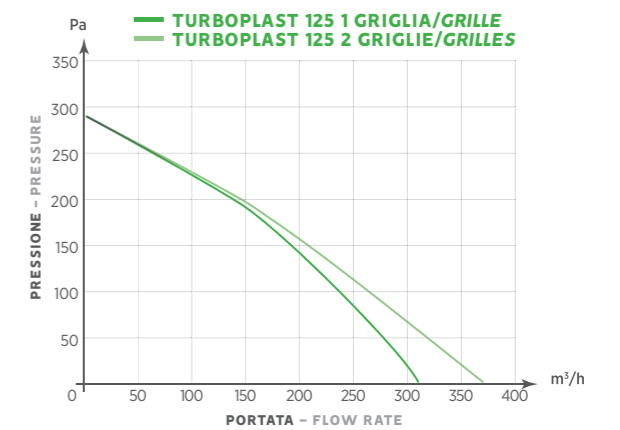
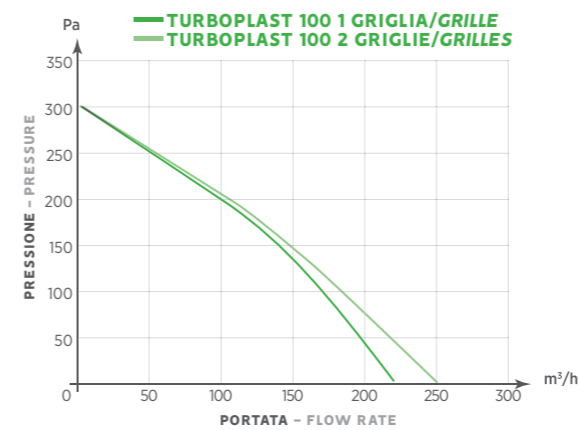

ACCESSORI (PAGINA 72, 74) – ACCESSORIES (PAGE 72, 74)



Regolatori
Controllers



Fascetta stringitubo
Duct clamp



Griglia di protezione
Protection grille



Serranda antiriflesso
Backdraught shutter

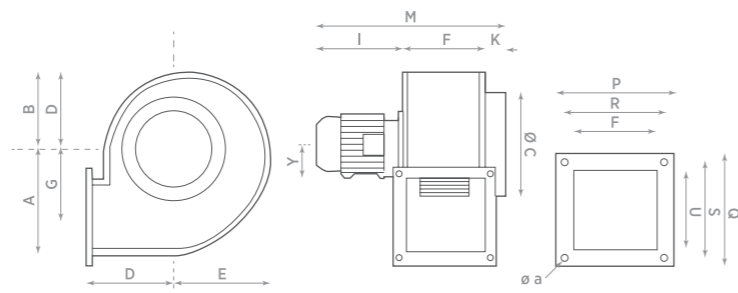

MODELLO MODEL	A	B	ØC	D	E	F	G	Y	K	I	M	P	Q	R	S	T	U	Øa
CB 210	80	66	68	86	72	60	50	-	-	110	170	100	100	85	85	58	58	5,7
CB 220	95	76	90	105	80	77	60	-	-	150	198	115	110	95	90	71	64	6,8
CB 230	139	108	180	127	122	94	91	63	42	190	326	135	135	114	114	88	90	8,2
CB 240	172	128	200	146	150	112	117	71	45	210	367	152	152	126	126	105	105	8,2



- Aspiratori centrifughi per l'espulsione di aria in condotti medio-lunghi.
- Applicabile su macchinari dove sia necessaria una ventilazione o aspirazione forzata;
- Alte pressioni in grado di superare perdite di carico notevoli dovute alle resistenze del condotto;
- Temperatura max aria aspirata: 50°C;
- Corpo in acciaio verniciato anti corrosione;
- Ventola in lamiera d'acciaio;
- Il prodotto standard viene fornito con la coclea in posizione CCW 270°;
- Su richiesta possono essere fornite posizioni della coclea e senso di rotazione diversi, come indicato nella tabella a pag. 77;
- Regolabili tramite i regolatori industriali (opzionale);
- Conforme ai requisiti essenziali della dir. 2006/42/CE relative alle macchine e alle NORME UNI EN ISO 13857 e 12499; CEI EN 60204 - 1.
- POSIZIONAMENTO:** a Parete

- Centrifugal duct fans to extract air and fumes through medium/long sized ducts.
- Suitable for application on machines where a forced ventilation or air suction is required;
- Temperature of extracted air: 50°C;
- Steel plated frame protected by an epoxy-based anticorrosive paint and aluminium centrifugal impeller statically and dynamically balanced;
- Suitable to overcome high pressure losses due to ducts resistance;
- Standard product supplied with impeller housing position CCW 270°, different positions available on request (see table on page 77);
- Motor speed can be regulated through industrial controllers (see accessories);
- Models CB 230 and CB 240 supplied with ball bearing motor, IP55 protected;
- In accordance with the essential requirements of 2006/42/EC Directive concerning machines and European Standards UNI EN ISO 13857; UNI EN ISO 12499; CEI EN 60204-1.
- POSITIONING:** Wall mounting

DATI TECNICI - TECHNICAL DATA

MODELLO MODEL	CODICE CODE	MOTORE MOTOR	N° POLI N° POLES	GIRI AL MINUTO REV. PER MIN. (RPM)	TENSIONE VOLTAGE (Volt)	FREQUENZA FREQUENCY (Hz)	PORTATA FLOW RATE m³/h	PRESS. MAX. MAX PRESS. (mm H ₂ O)	PRESS. MAX. MAX PRESS. (Pa)	POTENZA POWER (W)	CORR. NOM. (A) NOM. CURR. 230V 400V	IP MOTORE IP MOTOR	RUMOROSITÀ NOISE dB(A) _{1m}	PESO WEIGHT (kg)
CB 210 2M	0041000	single p.	2	2800	230	50	210	22	216	67	0,29	-	64	2,5
CB 220 2M	0041200	single p.	2	2500	230	50	380	35	343	115	0,49	-	68	3,5
CB 230 2M	0041400	single p.	2	2800	230	50	1000	66	650	400	1,8	-	76	6
CB 240 2M	0041600	single p.	2	2750	230	50	1450	87	850	900	3,5	-	83	10,5
CB 210 2T	0041100	three p.	2	2800	230/400	50	210	22	216	67	0,26	0,15	64	2,5
CB 220 2T	0041300	three p.	2	2500	230/400	50	380	35	343	110	0,36	0,21	68	3,5
CB 230 2T	0041500	three p.	2	2800	230/400	50	1000	69	650	400	1,75	1,0	76	6
CB 240 2T	0041700	three p.	2	2750	230/400	50	1450	87	850	900	2,4	1,4	83	10,5

AMBITI APPLICATIVI

- Indicato per installazione in ambito commerciale, terziario e industriale:
- Cucine e mense;
- Negozi;
- Uffici;
- Officine;
- Impianti sportivi;
- Supermercati e centri commerciali;
- Depositi e magazzini;
- Industrie;
- Macchinari

ENVIRONMENTS APPLICATION

- Suitable for installation in Commercial, industrial and tertiary environment:
- Kitchens and Canteens;
- Shops;
- Offices;
- Workshops;
- Sports facilities;
- Supermarkets and Shopping Centers;
- Warehouses;
- Factories;
- Machinery

GRAFICI DI PORTATA - FLOW CHARTS

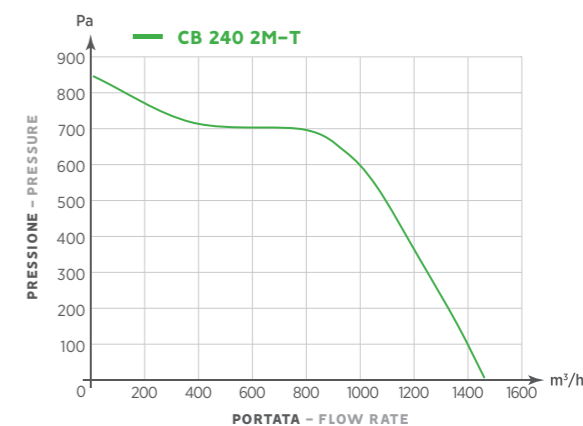
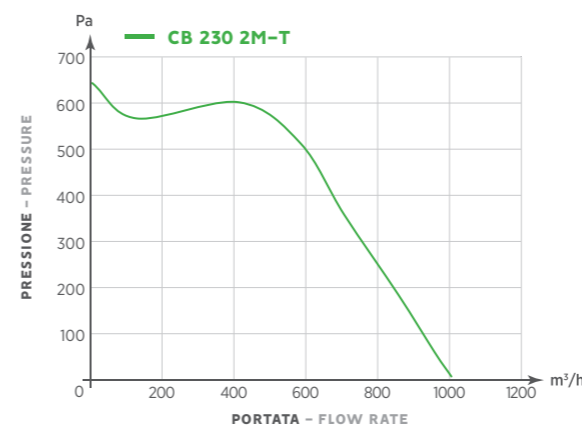
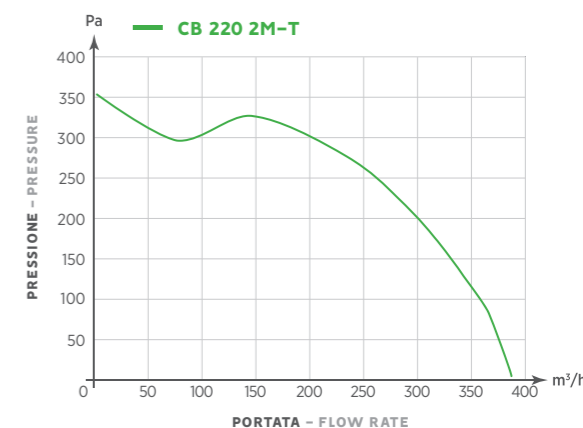
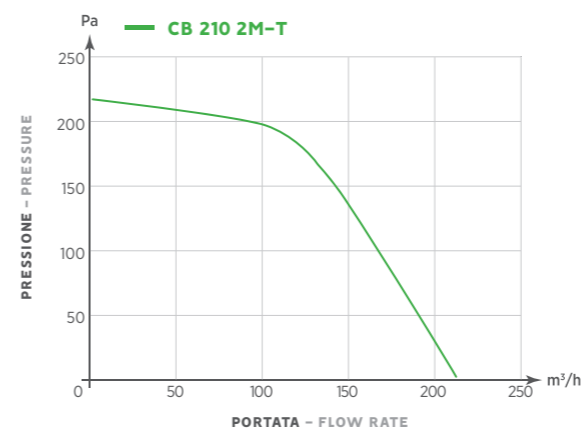

ACCESSORI (PAGINA 72) - ACCESSORIES (PAGE 72)



Regolatori
Controllers

ASPIRATORE CENTRIFUGO – CENTRIFUGAL FAN

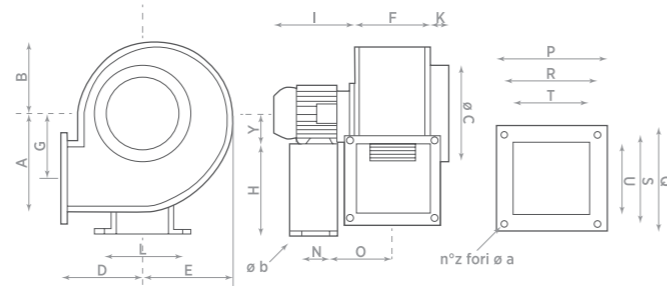

MODELLO MODEL	A	B	ØC	D	E	F	G	H	Y	K	I	L	N	O	P	Q	R	S	T	U	Z	Øa	Øb
CS 310	139	108	180	127	122	94	91	-	63	42	190	-	-	-	135	135	114	114	88	90	4	8,2	-
CS 320	172	128	200	146	150	112	117	-	63	45	190	-	-	-	152	152	126	126	105	105	4	8,2	-
CS 330	209	163	250	147	188	141	139	-	71	40	210	-	-	-	191	191	165	165	134	134	4	8,2	-
CS 340	250	194	250	178	222	164	162	-	80	45	240	-	-	-	225	235	195	205	161	170	4	8,2	-
CS 350	290	225	315	210	260	194	192	245	80	50	240	232	120	149	255	255	225	225	191	194	4	8,2	11
CS 360	290	225	315	210	260	194	192	245	90	50	255	232	120	155	255	255	225	225	191	194	4	8,2	11
CS 370	334	244	355	230	250	221	210	350	100	50	315	325	170	173	284	305	254	275	313	244	4	10,2	11
CS 380	429	315	400	300	370	249	280	350	112	62	330	325	170	194	310	360	280	330	241	295	8	9	11



Aspiratori centrifughi per l'espulsione in condotto di grossi volumi di aria non polverosa.

- Applicabile su macchinari dove sia necessaria ventilazione o aspirazione forzata;
- Bassa rumorosità in rapporto alle elevate prestazioni;
- Temperatura max aria aspirata: 50°C;
- Corpo in lamiera di acciaio verniciato a forno con polveri epossidiche anticorrosione;
- Ventola in lamiera di acciaio;
- Prodotto standard con coltela in posizione CCW 270
- Su richiesta fornito con posizioni coclea e senso di rotazione diversi (vedi tabella a pag. 77);
- Motore su cuscinetti a sfera per una lunga durata;
- Grado di protezione motore IP55;
- Regolabili mediante i regolatori industriali (opzionali);
- A partire dal modello 350, i prodotti sono dotati di supporto rigido (sedia) per facilitarne l'installazione;
- Conforme ai requisiti essenziali della dir. 2006/42/CE relativa alle macchine ed alle NORME UNI EN ISO 13857 e 12499; CEI EN 60204 - 1.
- **POSIZIONAMENTO:** a Parete

Centrifugal silenced duct fans to extract large air volumes and non dusty fumes.

- Suitable for application on machines where a forced ventilation or air suction is required;
- Max temperature of extracted air: 50°C;
- Low sound level and high performances;
- Steel plated frame protected by an epoxy-based anticorrosive paint and aluminium centrifugal impeller statically and dynamically balanced;
- Ball bearing class F insulation motor IP55 protected;
- Standard product supplied with impeller housing position CCW 270, different positions available on request, (see table on page 77);
- Motor speed can be regulated through industrial controllers (see accessories);
- In accordance with the essential requirements of 2006/42/EC Directive concerning machines and European Standards UNI EN ISO 13857; UNI EN ISO 12499; CEI EN 60204-1;
- Models CS 350, 360, 370 and 380: mounted on rigid base support to make installation easier.
- **POSITIONING:** Wall mounting

DATI TECNICI – TECHNICAL DATA

MODELLO MODEL	CODICE CODE	MOTORE MOTOR	N° POLI N° POLES	GIRI AL MINUTO REV. PER MIN. (RPM)	TENSIONE VOLTAGE (Volt)	FREQUENZA FREQUENCY (Hz)	PORTATA FLOW RATE m³/h	PRESS. MAX MAX PRESS. (mm H ₂ O)	PRESS. MAX MAX PRESS. (Pa)	POTENZA POWER (W)	CORR. NOM. (A) NOM. CURR. 230V 400V	IP MOTORE IP MOTOR	RUMOROSITÀ NOISE dB(A) _{1m}	PESO WEIGHT (Kg)
CS 310 4M	0042000	single p.	4	1400	230	50	500	16	155	110	0,72	-	64	8
CS 320 4M	0042200	single p.	4	1400	230	50	800	20	200	130	0,78	-	67	9
CS 310 4T	0042100	three p.	4	1400	230/400	50	500	16	155	110	0,7	0,4	64	8
CS 320 4T	0042300	three p.	4	1400	230/400	50	800	20	200	130	0,74	0,43	67	9
CS 330 4T	0042400	three p.	4	1400	230/400	50	1500	36	360	300	1,2	0,7	70	11
CS 340 4T	0042500	three p.	4	1400	230/400	50	2900	46	450	800	2,8	1,6	73	21
CS 350 4T	0042600	three p.	4	1400	230/400	50	4100	44	430	1300	4,0	2,3	76	24
CS 360 4T	0042700	three p.	4	1400	230/400	50	5200	64	630	1800	6,0	3,5	80	27
CS 370 4T	0042800	three p.	4	1400	230/400	50	6000	66	650	2600	8,7	5,0	84	42
CS 380 4T	0042900	three p.	4	1430	230/400	50	9500	97	950	4500	15	9,0	88	63

AMBITI APPLICATIVI

Indicato per installazione in ambito commerciale, terziario e industriale:

- Cucine e mense;
- Negozi;
- Uffici;
- Officine;
- Impianti sportivi;
- Supermercati e centri commerciali;
- Depositi e magazzini;
- Industrie;
- Macchinari.

ENVIRONMENTS APPLICATION

Suitable for installation in Commercial, industrial and tertiary environment:

- Kitchen and Canteens;
- Shops;
- Offices;
- Workshops;
- Sports facilities;
- Supermarkets and Shopping Centers;
- Warehouses;
- Factories;
- Machinery.

GRAFICI DI PORTATA – FLOW CHARTS

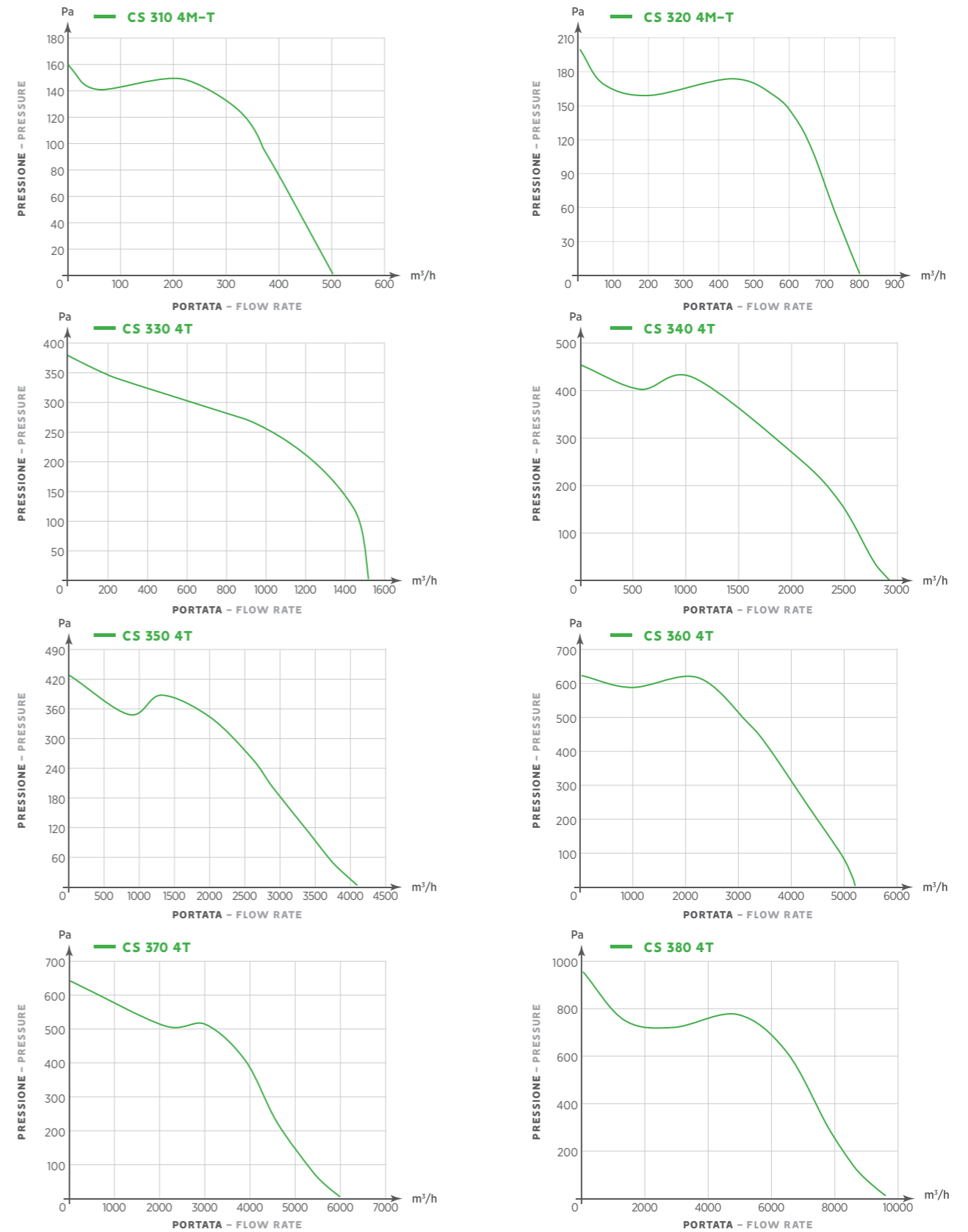

ACCESSORI (PAGINA 72) – ACCESSORIES (PAGE 72)



Regolatori
Controllers

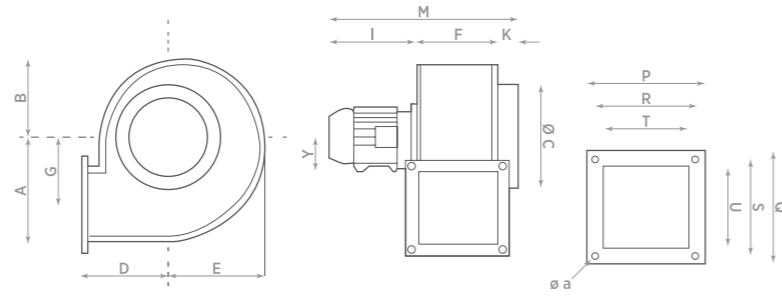

MODELLO	A	B	ØC	D	E	F	G	Y	K	I	M	P	Q	R	S	T	U	Øa
MODEL																		
CAI 510	80	66	68	86	72	60	50	-	-	110	170	100	100	85	85	58	58	5,7
CAI 520	95	76	90	105	80	77	60	-	-	121	198	115	110	95	90	71	64	6,8
CAI 530	139	108	180	127	122	94	91	63	42	190	326	135	135	114	114	88	90	8,2
CAI 540	172	128	200	146	150	112	117	71	45	210	367	152	152	126	126	105	105	8,2



- Aspiratori centrifughi per l'espulsione in condotto di aria con agenti chimici o per ambienti salini.
- Corpo in acciaio inossidabile AISI 304;
- Ventola in lamiera di acciaio;
- Applicabile su macchinari dove sia necessaria ventilazione o aspirazione forzata;
- Alte pressioni in grado di superare perdite di carico notevoli dovute alle resistenze del condotto;
- Particolarmente indicato per applicazioni dove è richiesto un alto grado di igiene (industrie alimentari);
- Temperatura max aria aspirata: 50°C;
- Su richiesta possono essere fornite posizioni della coclea e senso di rotazione diversi, come indicato nella tabella a pag. 77;
- Il prodotto standard viene fornito con la coltea in posizione CCW 270;
- Motore su cuscinetti a sfere (CAI 530 e CAI 540);
- Regolabili tramite i regolatori industriali (opzionali);
- Conforme ai requisiti essenziali della dir. 2006/42/CE relative alle macchine ed alle NORME UNI EN ISO 13857 e 12499; CEI EN 60204 - 1.
- POSIZIONAMENTO:** a Parete

- Centrifugal duct fans to extract air and fumes with chemical agents or for salt environments.
- Suitable for application on machines where a forced ventilation or air suction is required;
- Particularly suitable for applications where a high degree of hygiene (food industries) is necessary;
- Max temperature of extracted air: 50°C;
- Body and impeller in AISI 304 stainless steel;
- Suitable to overcome high pressure losses due to ducts resistance;
- Standard product supplied with impeller housing position CCW 270, different positions available on request, (see table on page 77);
- Motor speed can be regulated through industrial controllers (see accessories);
- Models CAI 530 and CAI 540 supplied with ball bearing motor, IP55 protected;
- In accordance with the essential requirements of 2006/42/EC Directive concerning machines and European Standards UNI EN ISO 13857; UNI EN ISO 12499; CEI EN 60204-1.
- POSITIONING:** Wall mounting

DATI TECNICI - TECHNICAL DATA

MODELLO	CODICE	MOTORE	N° POLI	GIRI AL MINUTO	TENSIONE	FREQUENZA	PORTATA	PRESS. MAX	PRESS. MAX	POTENZA	CORR. NOM. (A)	IP MOTORE	RUMOROSITÀ	PESO
MODEL	CODE	MOTOR	N° POLES	REV. PER MIN.	VOLTAGE	FREQUENCY	FLOW RATE	MAX PRESS.	MAX PRESS.	POWER	NOM. CURR.	IP MOTOR	NOISE	WEIGHT
				(RPM)	(Volt)	(Hz)	(m³/h)	(mm H₂O)	(Pa)	(W)	230V 400V		dB(A) _{1m}	(Kg)
CAI 510 2M	0048000	single p.	2	2800	230	50	210	22	216	67	0,29	-	64	2,6
CAI 520 2M	0048200	single p.	2	2500	230	50	380	35	343	115	0,49	-	68	3,2
CAI 530 2M	0048400	single p.	2	2800	230	50	1000	66	650	400	1,8	-	76	7,0
CAI 540 2M	0048600	single p.	2	2750	230	50	1450	87	850	900	3,5	-	83	10,7
CAI 510 2T	0048100	three p.	2	2800	230/400	50	210	22	216	67	0,26	0,15	64	2,6
CAI 520 2T	0048300	three p.	2	2500	230/400	50	380	35	343	110	0,36	0,21	68	3,2
CAI 530 2T	0048500	three p.	2	2800	230/400	50	1000	66	650	400	1,75	1,0	76	7,0
CAI 540 2T	0048700	three p.	2	2750	230/400	50	1450	87	850	900	2,4	1,4	83	10,7

AMBITI APPLICATIVI

- Indicato per installazione prevalentemente in ambito industriale alimentare dove è richiesto un alto grado di igiene:
- Cucine e mense

ENVIRONMENTS APPLICATION

- Particularly suitable for industrial alimentary applications where a high level of hygiene is required.
- Kitchens and Canteens.

GRAFICI DI PORTATA - FLOW CHARTS

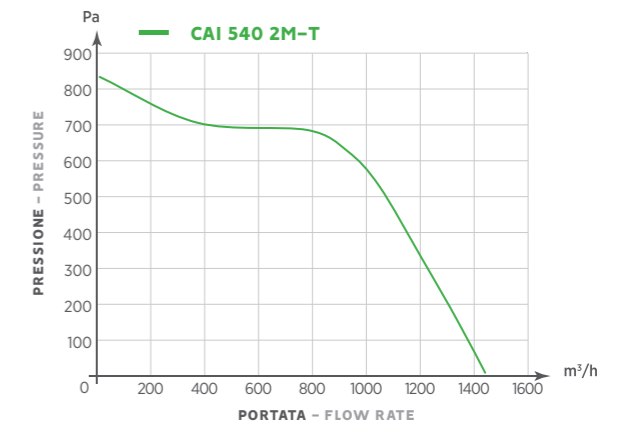
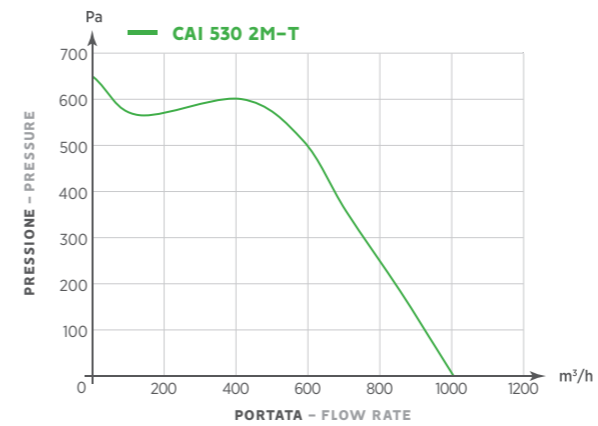
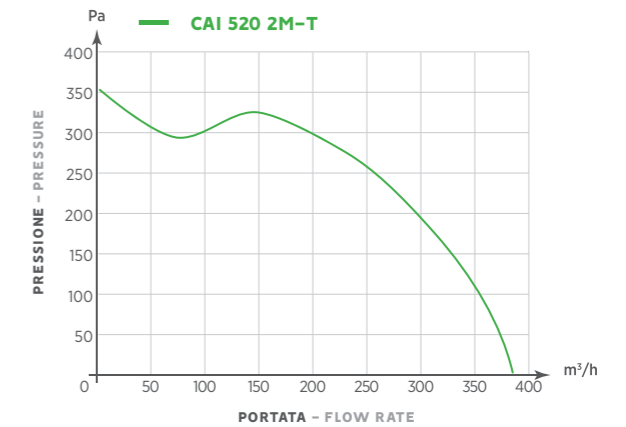
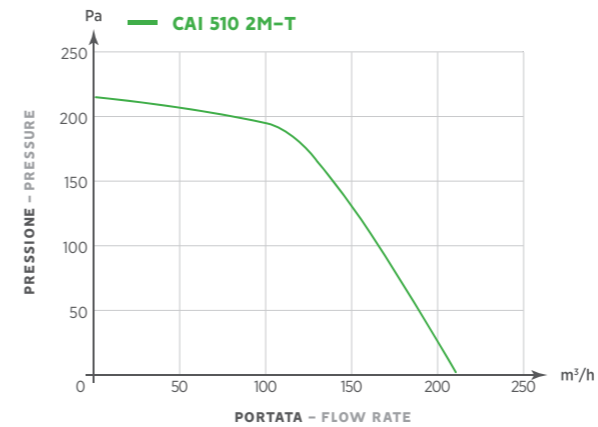

ACCESSORI (PAGINA 72) - ACCESSORIES (PAGE 72)



Regolatori
Controllers

ASPIRATORE CENTRIFUGO - CENTRIFUGAL FAN

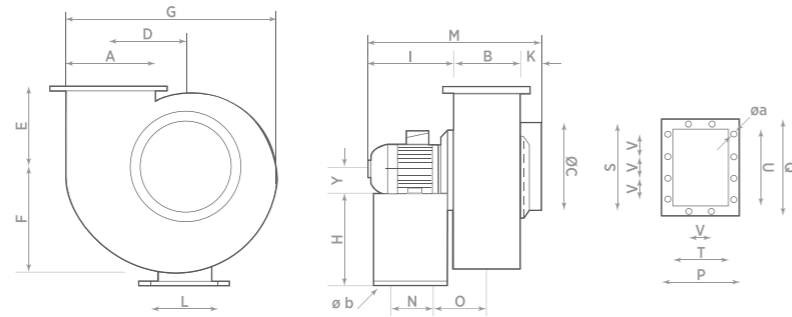

MODELLO	A	B	ØC	D	E	F	G	H	Y	K	I	L	N	O	P	Q	R	S	T	U	V	Øa	Øb	N° FORI
MODEL																								N° HOLES
CAA 610	90	90	125	103	109	133	270	130	55	28	179	175	130	80	135	135	110	110	85	85	-	7,5	10	4
CAA 620	165	135	200	148	148	201	397	200	63	48	220	215	170	95	180	210	164	194	130	160	85	7	10	6+2
CAA 630	205	165	250	185	180	240	503	250	80	45	245	255	175	125	228	266	200	240	160	200	80	7	10	8+2
CAA 640	245	205	315	222	218	293	590	310	90	65	282	234	175	155	265	306	241	282	195	240	100	9	12	6+4
CAA 650	290	235	355	259	268	356	699	320	100	60	315	285	200	170	305	356	275	326	225	280	100	9	12	8+4



Aspiratori centrifughi per l'espulsione in condotti di aria e fumi con agenti chimici e corrosivi (acido solforico, nitrico, trielina, benzina, ecc.).

- Applicabile su macchinari dove è necessaria una ventilazione o aspirazione forzata;
- Corpo e ventola in polipropilene con mozzoin nylon grafitato;
- Motore su cuscinetti a sfera, protezione IP55, classe F
- Temperatura max aria aspirata: 50°C;
- Il prodotto standard viene fornito con la coclea in posizione CCW 360;
- Su richiesta possono essere fornite posizioni della coclea e senso di rotazione diversi, come indicato nella tabella a pag. 77;
- Dotati di supporto rigido (sedia) per facilitarne l'installazione;
- Regolabili tramite i regolatori industriali (opzionali);
- Conforme ai requisiti essenziali della dir. 2006/42/CE relative alle macchine ed alle NORME UNI EN ISO 13857 e 12499; CEI EN 60204 - 1.
- **POSIZIONAMENTO:** a Parete

Centrifugal duct fans to extract air and fumes with chemical and corrosive agents (sulphuric and nitric acid; trichloroethylene, petrol, etc.).

- Suitable for application on machines where a forced ventilation or air suction is required;
- Frame and impeller in polypropylene with nylon hub graphite treated;
- Max temperature of extracted air: 50°C;
- Ball bearing class F insulation motor IP55 protected;
- Standard product supplied with impeller housing position CCW 360, different positions available on request, (see table on page 77), model 610 not available in CW position;
- Motor speed can be regulated through industrial controllers (see accessories);
- In accordance with the essential requirements of 2006/42/EC Directive concerning machines and European Standards UNI EN ISO 13857; UNI EN ISO 12499; CEI EN 60204-1.
- **POSITIONING:** Wall mounting

DATI TECNICI - TECHNICAL DATA

MODELLO	CODICE	MOTORE	N° POLI	GIRI AL MINUTO	TENSIONE	FREQUENZA	PORTATA	PRESS. MAX.	PRESS. MAX.	POTENZA	CORR. NOM. (A)	IP MOTORE	RUMOROSITÀ	PESO
MODEL	CODE	MOTOR	N° POLES	REV. PER MIN.	VOLTAGE	FREQUENCY	FLOW RATE	MAX PRESS.	MAX PRESS.	POWER	NOM. CURR.	IP MOTOR	NOISE	WEIGHT
				(RPM)	(Volt)	(Hz)	(m³/h)	(mm H₂O)	(Pa)	(W)	230V 400V		dB(A) _{1m}	(Kg)
CAA 610 2T	0044000	three p.	2	2800	230/400	50/60	615	52	505	220	0,83 0,48	IP55	65	6
CAA 620 2T	0044100	three p.	2	2800	230/400	50/60	2550	102	1000	1500	3,45 2	IP55	68	13
CAA 620 4T	0044200	three p.	4	1400	230/400	50/60	1280	25	240	270	1,18 0,68	IP55	55	13
CAA 630 4T	0044300	three p.	4	1400	230/400	50/60	2550	42	410	800	2,6 1,5	IP55	64	19
CAA 640 4T	0044400	three p.	4	1400	230/400	50/60	4000	61	600	1300	4,3 2,5	IP55	65	31
CAA 650 4T	0044500	three p.	4	1400	230/240	50/60	7500	87	850	4100	11,8 7	IP55	70	64

AMBITI APPLICATIVI

Indicato per installazione in ambito terziario e industriale dove sono presenti fumi con agenti chimici e corrosivi:

- Officine;
- Depositi e magazzini;
- Industrie;
- Macchinari

ENVIRONMENTS APPLICATION

Suitable for installation in tertiary and industrial environments with high presence of fumes with chemical and corrosive agents:

- Workshops;
- Warehouses;
- Factories;
- Machinery.

GRAFICI DI PORTATA - FLOW CHARTS

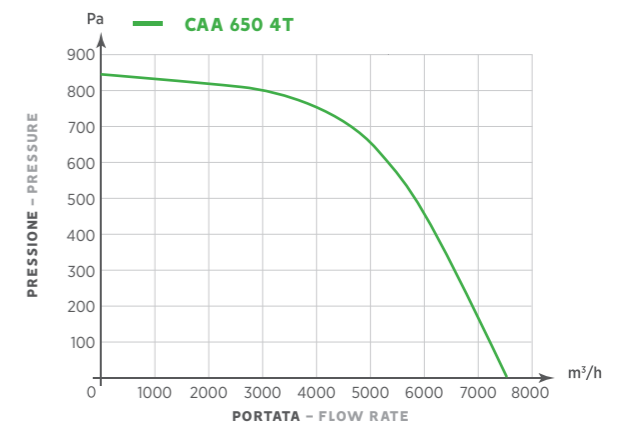
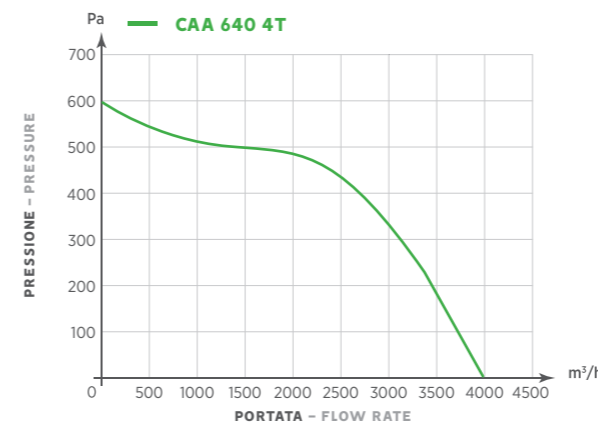
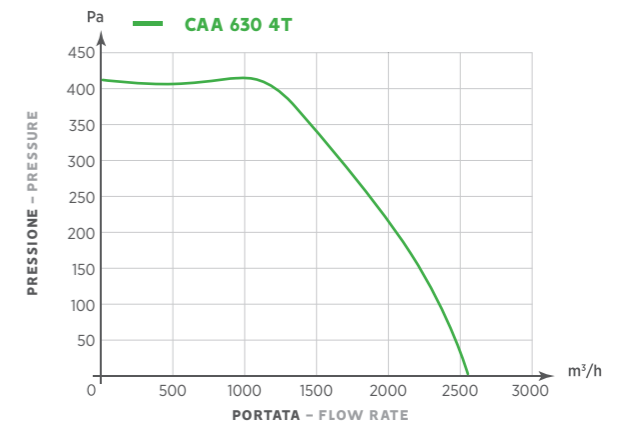
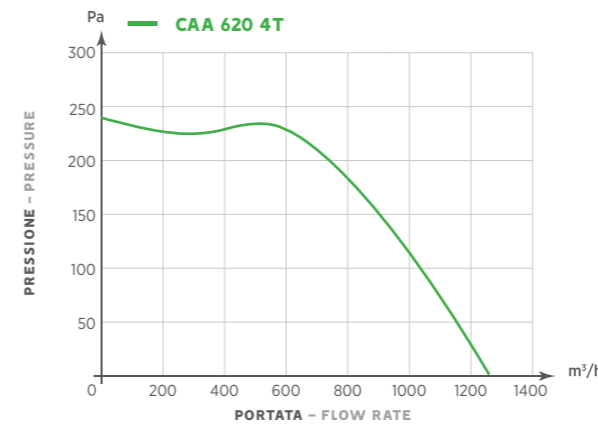
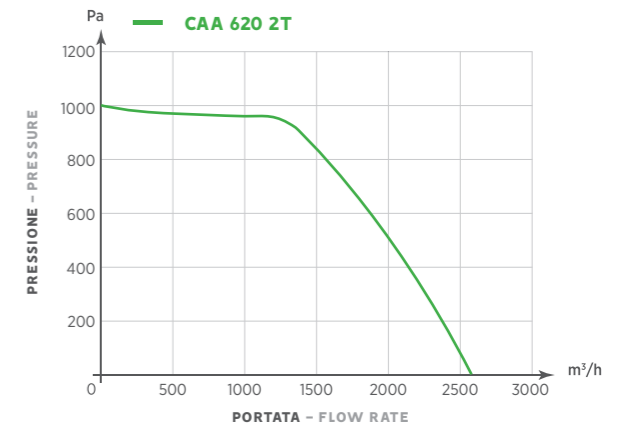
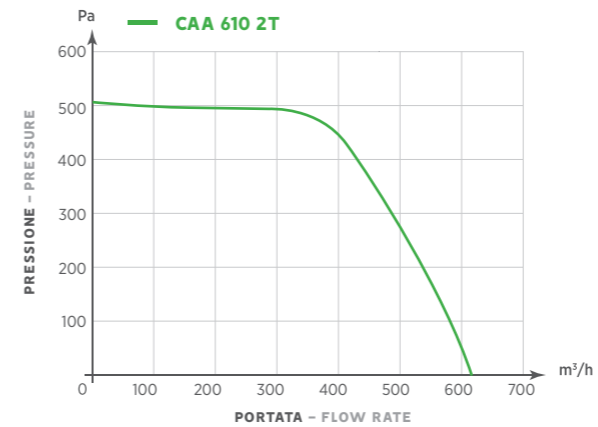

ACCESSORI (PAGINA 72) - ACCESSORIES (PAGE 72)



Regolatori
Controllers

ASPIRATORE CENTRIFUGO AD ANGOLO - CENTRIFUGAL FAN

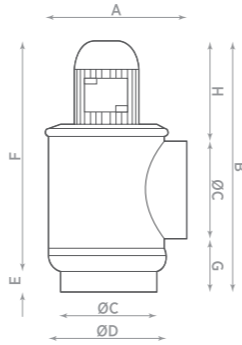

MODELLO	A	B	ØC	ØD	E	F	G	H
MODEL AC 150	230	340	148	185	25	315	65	150



- Aspiratori centrifughi ad angolo per convogliare in condotti aria e fumi non polverosi.
- Applicabile su macchinari dove sia necessaria una ventilazione o aspirazione forzata;
- Temperatura max aria aspirata: 70°C;
- Corpo in lamiera d'acciaio verniciato a forno con ventola in lamiera d'acciaio;
- Motore montato su cuscinetti a sfera per una lunga durata;
- Regolabili tramite i regolatori industriali (opzionali);
- Conforme ai requisiti essenziali della dir. 2006/42/CE relative alle macchine ed alle NORME UNI EN ISO 13857 e 12499; CEI EN 60204 - 1.
- POSIZIONAMENTO:** a Parete

- Centrifugal angle duct fans to extract air and non dusty fumes.
- Suitable for application on machines where a forced ventilation or air suction is required;
- Steel plated frame protected by an epoxy-based anticorrosive paint and zinc plated steel impeller;
- Ball bearing motor;
- External motor allows to extract air with temperature up to 70°C;
- Motor speed can be regulated through industrial controllers (see accessories);
- In accordance with the essential requirements of 2006/42/EC Directive concerning machines and European Standards UNI EN ISO 13857; UNI EN ISO 12499; CEI EN 60204-1.
- POSITIONING:** Wall mounting

DATI TECNICI - TECHNICAL DATA

MODELLO	CODICE	MOTORE	N° POLI	GIRI AL MINUTO	TENSIONE	FREQUENZA	PORTATA	PRESS. MAX	PRESS. MAX	POTENZA	CORR. NOM. (A)	IP MOTORE	RUMOROSITÀ	PESO
MODEL	CODE	MOTOR	N° POLES	REV. PER MIN.	VOLTAGE	FREQUENCY	FLOW RATE	MAX PRESS.	MAX PRESS.	POWER	NOM. CURR.	IP MOTOR	NOISE	WEIGHT
				(RPM)	(Volt)	(Hz)	(m³/h)	(mm H ₂ O)	(Pa)	(W)	230V 400V		dB(A) _{1m}	(kg)
AC 150 2M	0044600	single p.	2	2700	230	50/60	400	18,3	180	110	0,5 -	IP44	62	3,5
AC 150 2T	0044700	three p.	2	2700	230/400	50/60	400	18,3	180	100	0,4 0,25	IP54	62	3,5

AMBITI APPLICATIVI

- Indicato per installazione in ambito commerciale, terziario e industriale:
- Cucine e mense
- Negozi
- Uffici
- Officine
- Impianti sportivi
- Supermercati e centri commerciali
- Depositi e magazzini
- Industrie
- Macchinari

ENVIRONMENTS APPLICATION

- Suitable for installation in Commercial, industrial and tertiary environment:
- Kitchen and Canteens;
- Shops;
- Offices;
- Workshops;
- Sports facilities;
- Supermarkets and Shopping Centers;
- Warehouses;
- Factories;
- Machinery.

GRAFICI DI PORTATA - FLOW CHARTS

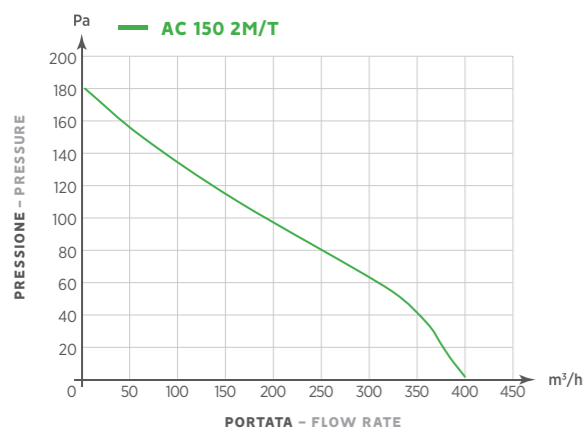

ACCESSORI (PAGINA 72) - ACCESSORIES (PAGE 72)



Regolatori
Controllers

CASSONATO - BOX FAN

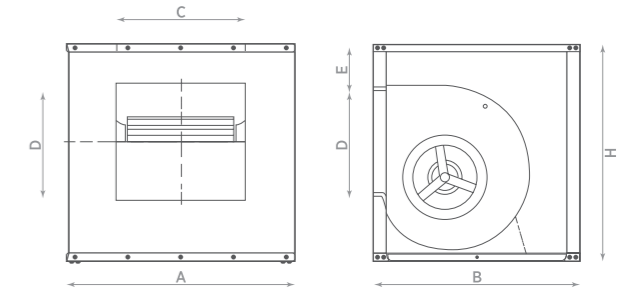
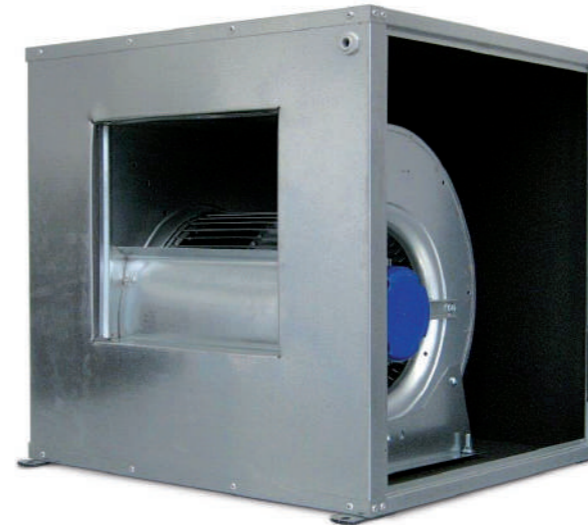

MODELLO	VENT	A	H	B	BOCCA DI MANDATA	CXD	E	L
MODEL					OUTLET CXD			
CV-D	7/7	450	460	500	230x208		120	121
CV-D	9/7	500	520	550	230x263		110	118
CV-D	9/9	500	520	550	300x263		110	118
CV-D	10/8	550	575	600	260x292		120	516
CV-D	10/10	550	575	600	326x292		115	129
CV-D	12/9	650	650	700	300x345		115	152
CV-D	12/12	650	650	700	300x345		115	152



- Ventilatori cassonati ad accoppiamento diretto dotati di rivestimento interno fonoassorbente, equipaggiati con gruppo ventilante a doppia aspirazione e ventola centrifuga a pale avanti. Facilmente utilizzabili in impianti di aspirazione canalizzati.
- Gamma composta da 8 formati, con portate da 1230 a 11900 m³/h.
- Temperatura di funzionamento: +60°C;
- Struttura leggera autoportante in lamiera d'acciaio zincato con rivestimento interno in materiale fonoassorbente di spessore 5 mm.
- Completo di pressacavo per l'ingresso del cavo di alimentazione
- Porta di ispezione lato motore con chiusura a norme CE;
- Motore monofase 230V o trifase 400V, direttamente accoppiato, protezione IP54, classe F;
- Velocità singola di funzionamento;
- Conforme ai requisiti essenziali della dir. 2006/42/CE relative alle macchine e alle NORME UNI EN ISO 13857 e 12499; CEI EN 60204 - 1.
- POSIZIONAMENTO:** a Pavimento, a Mensola, a Sospensione

- Box fans directly driven with sound absorbing lining, equipped with double inlet centrifugal fan with forward curved blades. Highly suitable in ventilation systems.
- Series composed by 8 sizes, with flow rate starting from 1.230 m³/h up to 11.900 m³/h;
- Working temperature: +60°C;
- Lightweight self-supporting galvanised steel sheet lined with sound-absorbing material of thickness 5 mm
- Equipped with power supply cable gland;
- Inspection door motor side with lock system CE compliance;
- Single phase motor 230V or three phase 400V, direct coupled, IP54 protected, Class F;
- Single speed as default.
- It complies with the essential requirements of Dir. 2006/42/CE for machinery and with the norms UNI EN ISO 13857 and 12499; CEI EN 60204 - 1.
- POSITIONING:** Floor mounting, Shelf mounting, Ceiling mounting

DATI TECNICI - TECHNICAL DATA

MODELLO	CODICE	MOTORE	N° POLI	GIRI AL MINUTO	TENSIONE	FREQUENZA	PORTATA	PRESS. MAX	PRESS. MAX	POTENZA	CORR. NOM. (A)	IP MOTORE	RUMOROSITÀ	PESO
MODEL	CODE	MOTOR	N° POLES	REV. PER MIN.	VOLTAGE	FREQUENCY	FLOW RATE	MAX PRESS.	MAX PRESS.	POWER	NOM. CURR.	IP MOTOR	NOISE	WEIGHT
				(RPM)	(Volt)	(Hz)	(m³/h)	(mm H ₂ O)	(Pa)	(W)	230V 400V		dB(A) _{1m}	(kg)
CV-D 7/7 4M	0012802	single p.	4	1230	230	50	1520	26	255	0,15	1,4 -	IP54	56	20
CV-D 7/7 6M	0012804	single p.	6	820	230	50	1230	13	128	0,07	0,6 -	IP54	50	20
CV-D 9/7 4M	0012806	single p.	4	1320	230	50	2600	47	461	0,37	2,9 -	IP54	63	26,8
CV-D 9/9 4M	0012810	single p.	4	1320	230	50	2800	37	363	0,37	2,9 -	IP54	63	29
CV-D 9/9 6M	0012812	single p.	6	850	230	50	2800	21,5	210	0,20	1,8 -	IP54	60	30
CV-D 10/8 4M	0012814	single p.	4	1310	230	50	3600	52	510	0,55	5,7 -	IP54	67	33
CV-D 10/8 6M	0012816	single p.	6	830	230	50	2900	25	245	0,25	2,3 -	IP54	61	33
CV-D 10/10 4M	0012818	single p.	4	1320	230	50	2800	47	461	0,37	2,9 -	IP54	62	33
CV-D 10/10 6M	0012820	single p.	6	830	230	50	3200	22	216	0,25	2,3 -	IP54	59	32,5
CV-D 12/9 6M	0012822	single p.	6	900	230	50	5500	34	334	0,55	4,7 -	IP54	66	44,8
CV-D 12/12 6M	0012824	single p.	6	850	230	50	4900	30	294	0,55	4,7 -	IP54	61	46,4
CV-D 12/12 6T	0012803	three p.	6	850	400	50	7800	32	314	1,10	4,8 2,8	IP54	72	48

AMBITI APPLICATIVI

- I ventilatori CV-D sono consigliati per le applicazioni civili ed industriali dove l'aria da trattare è pulita ed è necessario installare una macchina silenziosa ed affidabile:
- Negozi
- Laboratori
- Officine artigianali
- Ristoranti, bar, mense
- Uffici
- Unità abitative

ENVIRONMENTS APPLICATION

- CV-D box fans are recommended for domestic and industrial applications where the air to be treated is clean and a noiseless and reliable machine is required for installation
- Shops;
- Laboratories;
- Craft workshops;
- Restaurants, bars, canteens;
- Offices;
- Houses

GRAFICI DI PORTATA - FLOW CHARTS

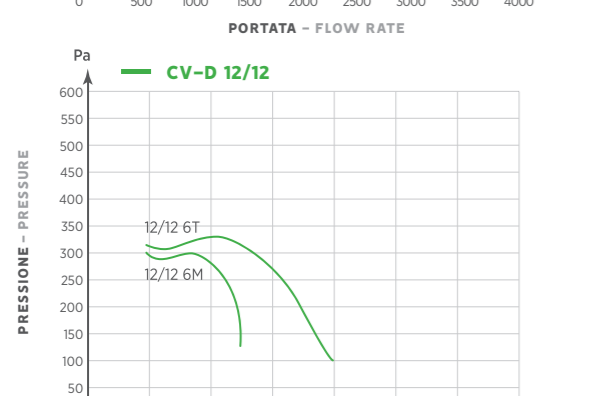
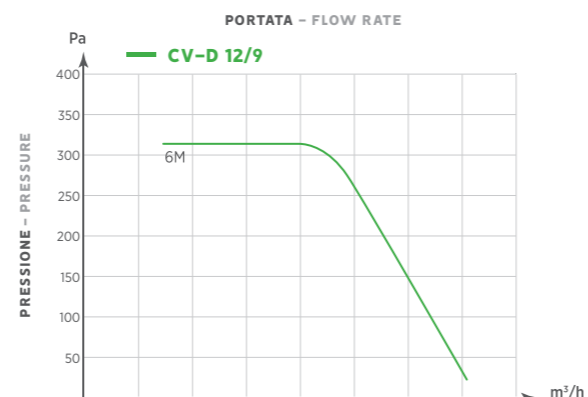
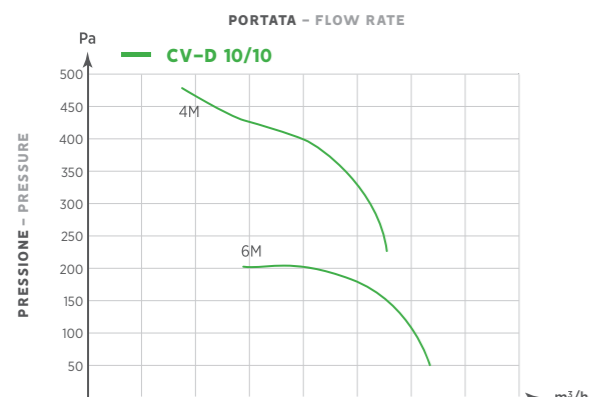
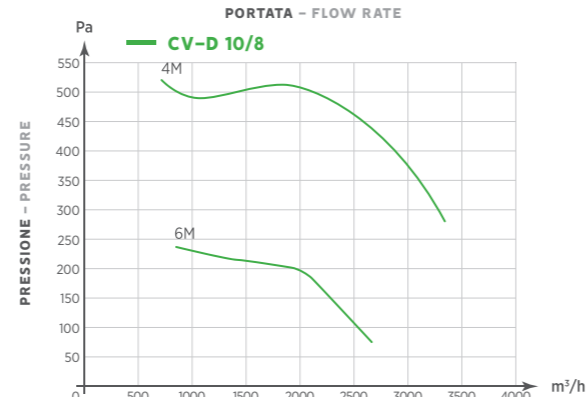
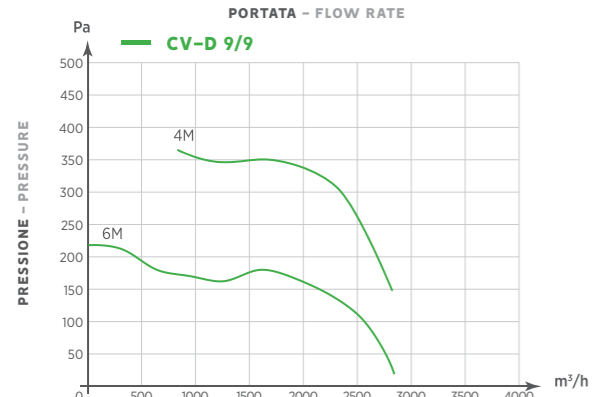
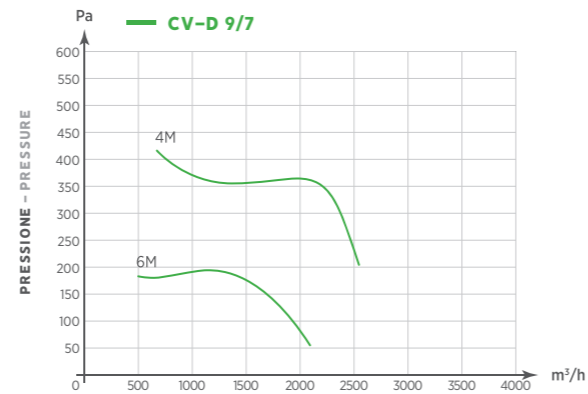
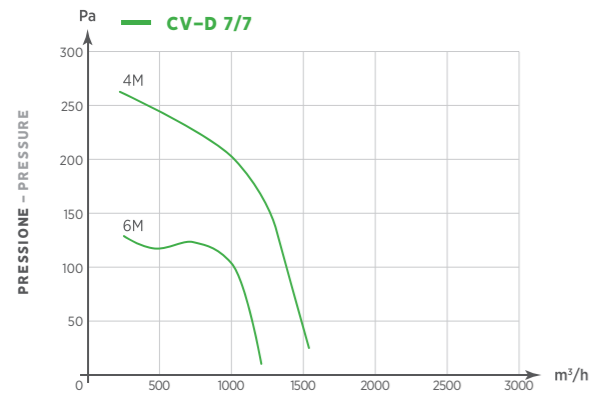

ACCESSORI DISPONIBILI SU RICHIESTA - ACCESSORIES AVAILABLE ON DEMAND

Regolatore di velocità monofase
Single-phase speed controller

Tronchetto di espulsione con rete di protezione
Outlet connection with protection grille

Piedini di appoggio
Rubber feet

Tetto parapigioggia
Rain cover

CV-2P

CASSONATO - BOX FAN

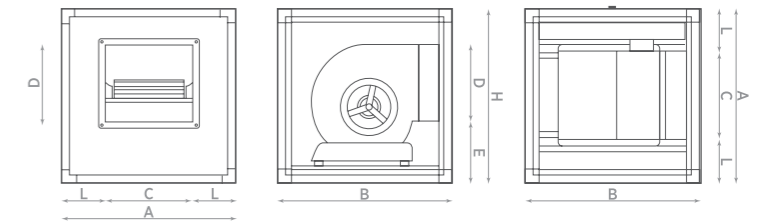

MODELLO	VENT	A	H	B	BOCCA DI MANDATA CXD	E	L
MODEL					OUTLET CXD		
CV-2P	7/7	500	500	500	232x210	188	134
CV-2P	9/7	600	600	600	232x265	195	134
CV-2P	9/9	600	600	600	302x265	195	149
CV-2P	10/8	600	600	600	262x294	120	516
CV-2P	10/10	600	600	600	328x294	225	169
CV-2P	12/9	750	750	750	302x347	250	224
CV-2P	12/12	650	650	700	389x347	250	180



- Ventilatori cassonati ad accoppiamento diretto con telaio portante in alluminio e doppia pannellatura con riempimento fonoassorbente, equipaggiati con gruppo ventilante a doppia aspirazione e ventola centrifuga a pale avanti. Progettati per l'utilizzo in impianti di aspirazione canalizzati di tipo professionale, ove siano necessari silenziosità di funzionamento ed isolamento termico.
- Gamma composta da 7 formati, con portate da 1200 a 8000 m³/h e pressioni da 125 a 550 Pa;
- Temperatura di esercizio: +60°C;
- Telaio struttura portante realizzato con profilati estrusi in alluminio;
- Pannelli di rivestimento in lamiera d'acciaio, esterno verniciata colore RAL 7032 ed interno zincata, con interposti 25 mm di poliuretano espanso ad alta densità, avente potere fonoisolante Rw=40db ed isolamento termico
- Porta di ispezione con chiusura a norme CE completa di maniglia;
- Motore monofase 230V o trifase 400V, direttamente accoppiato, protezione IP54, classe F;
- Velocità singola di funzionamento, versione a tre velocità fornibile a richiesta;
- Conforme ai requisiti essenziali della dir. 2006/42/CE relative alle macchine e alle NORME UNI EN ISO 13857 e 12499; CEI EN 60204 - 1.
- POSIZIONAMENTO:** a Pavimento, a Mensola, a Sospensione

Box fans directly driven with sound absorbing lining, equipped with double inlet centrifugal fan with forward curved blades. Highly suitable in ventilation systems.

- Series composed by 7 sizes, with flow rate starting from 1.230 m³/h up to 11.900 m³/h;
- Working temperature : +60°C;
- Lightweight self-supporting galvanised steel sheet lined with sound-absorbing material of thickness 5 mm
- Equipped with power supply cable gland;
- Inspection door motor side with lock system CE compliance;
- Single phase motor 230V or three phase 400V, direct coupled, IP54 protected, Class F;
- Single speed as default, three speed version available on request.
- POSITIONING:** Floor mounting, Shelf mounting, Ceiling mounting

DATI TECNICI - TECHNICAL DATA

MODELLO	CODICE	MOTORE	N° POLI	GIRI AL MINUTO	TENSIONE	FREQUENZA	PORTATA	PRESS. MAX	PRESS. MAX	POTENZA	CORR. NOM. (A)	IP MOTORE	RUMOROSITÀ	PESO	
MODEL	CODE	MOTOR	N° POLES	REV. PER MIN.	VOLTAGE	FREQUENCY	FLOW RATE	MAX PRESS.	MAX PRESS.	POWER	NOM. CURR.	IP MOTOR	NOISE	WEIGHT	
				(RPM)	(Volt)	(Hz)	(m³/h)	(mm H ₂ O)	(Pa)	(W)	230V 400V		dB(A) _{1m}	(Kg)	
CV-2P 7/7 4M	0012902	single p.	4	1230	230	50	1500	25	250	0,15	1,4	-	IP54	54	30
CV-2P 7/7 6M	0012904	single p.	6	820	230	50	1200	12,5	125	0,07	0,6	-	IP54	48	30
CV-2P 9/7 4M	0012906	single p.	4	1320	230	50	3000	42,5	425	0,37	2,9	-	IP54	57	38
CV-2P 9/7 6M	0012908	single p.	6	850	230	50	2200	19	190	0,25	2,3	-	IP54	53	38
CV-2P 9/9 4M	0012910	single p.	4	1320	230	50	3500	38	380	0,37	2,9	-	IP54	56	40
CV-2P 9/9 6M	0012912	single p.	6	860	230	50	2600	16	160	0,15	1,2	-	IP54	54	40
CV-2P 10/8 4M	0012914	single p.	4	1310	230	50	3500	55	550	0,55	5,7	-	IP54	59	67
CV-2P 10/8 6M	0012916	single p.	6	830	230	50	2900	29	290	0,25	2,3	-	IP54	55	67
CV-2P 10/10 4M	0012918	single p.	4	1310	230	50	3300	50	500	0,55	5,7	-	IP54	61	50
CV-2P 10/10 6M	0012920	single p.	6	830	230	50	3000	22	220	0,25	2,3	-	IP54	55	50
CV-2P 12/9 6M	0012922	single p.	6	900	230	50	4700	36	360	0,75	4,7	-	IP54	63	63
CV-2P 12/12 6M	0012924	single p.	6	850	230	50	6000	33	330	0,75	2,0	-	IP54	61	62
CV-2P 12/9 6T	0012901	three p.	6	850	400	50	7000	40	400	1,10	4,8 2,8	-	IP54	65	63
CV-2P 12/12 6T	0012903	three p.	6	890	400	50	8000	35	350	1,10	4,8 2,8	-	IP54	65	62

AMBITI APPLICATIVI

I ventilatori CV-2P sono ideali per applicazioni professionali dove è necessario installare una macchina assolutamente silenziosa ed affidabile.

- Uffici;
- Scuole, nidi d'infanzia, scuole materne;
- Cliniche ed ambulatori medici;
- Ristoranti, bar, mense;
- Unità abitative;
- Negozi;
- Laboratori;
- Servizi igienici

ENVIRONMENTS APPLICATION

CV-2P box fans are ideal for professional applications where an absolutely noiseless and reliable machine is required for installation

- Offices;
- Schools, crèches, nursery schools;
- Hospitals and surgeries;
- Restaurants, bars, canteens;
- Houses;
- Shops;
- Laboratories;
- Toilets

GRAFICI DI PORTATA - FLOW CHARTS

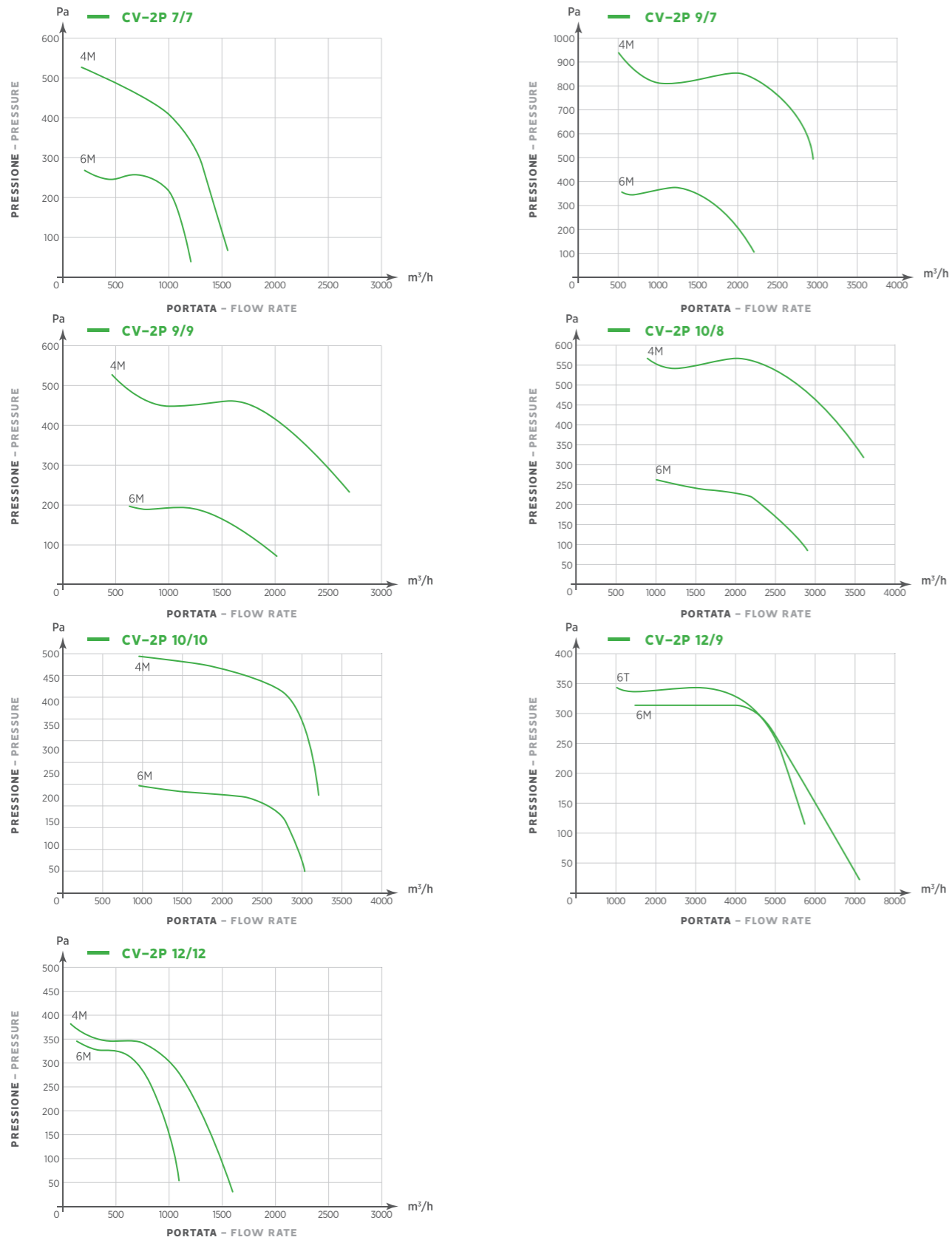

ACCESSORI DISPONIBILI SU RICHIESTA - ACCESSORIES AVAILABLE ON DEMAND

Giunto antivibrante flangiato
Anti-vibration flanged joint

Tronchetto di espulsione con rete di protezione
Outlet connection with protection grille

Piedini di appoggio
Rubber feet

Tetto parapoggia
Rain cover

CV-T

CASSONATO - BOX FAN

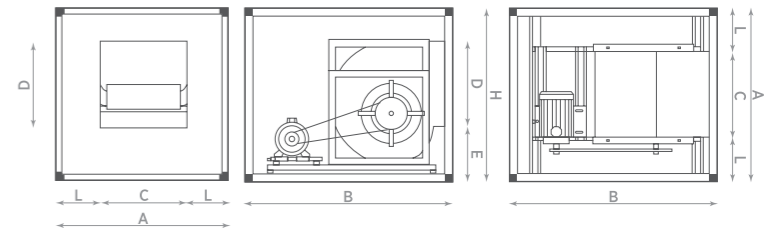

MODELLO	VENT	A	H	B	BOCCA DI MANDATA CXD	E	L
MODEL					OUTLET CXD		
CV-T	7/7	600	600	600	232x210	198	184
CV-T	9/7	600	600	750	302x265	205	149
CV-T	10/10	750	750	900	302x265	195	149
CV-T	12/12	750	750	900	262x294	120	516
CV-T	15/15	900	900	1000	475x406	285	212
CV-T	18/18	1000	1000	1200	542x484	353	229



- Ventilatori cassonati con trasmissione a cinghia aventi telaio portante in alluminio e doppia pannelatura con riempimento fonoassorbente, equipaggiati con gruppo ventilante a doppia aspirazione e ventola centrifuga a pale avanti. Progettati per l'inserimento in impianti di aspirazione canalizzati di tipo professionale, particolarmente adatti ove siano necessari una elevata silenziosità di funzionamento ed un buon isolamento termico.
- Gamma composta da 6 formati, con portate da 800 a 16000 m³/h e pressioni da 100 a 800 Pa;
- Temperatura di funzionamento: +60°C;
- Telaio struttura portante realizzato con profilati estrusi in alluminio;
- Pannelli di rivestimento in lamiera d'acciaio, esterno verniciata colore RAL 7032 ed interno zincata, con interposti 25 mm di poliuretano espanso ad alta densità, avente potere fonoisolante $R_w = 40$ db e conducibilità termica di 0,0247 W/(m °K);
- Porta di ispezione con chiusura a norme CE completa di maniglia;
- Motore UNEL-MEC asincrono trifase 400V con isolamento in classe F e grado di protezione IP55;
- Velocità singola di funzionamento, versione a due velocità fornibile a richiesta;
- Conforme ai requisiti essenziali della dir. 2006/42/CE relative alle macchine e alle NORME UNI EN ISO 13857 e 12499; CEI EN 60204 - 1.
- POSIZIONAMENTO:** a Pavimento, a Mensola, a Sospensione

- Box belt driven fans with frame in aluminium paneling and acoustic cladding equipped with double inlet fan with forward curved blades. Designed for use in professional ventilation systems, where low noise and thermal insulation are required.
- Series composed by 6 sizes, with flowrate starting from 800 m³/h up to 16.000 m³/h and pressure from 100 up to 800 Pa;
- Working temperature: +60°C;
- Cladding panels made in sheet steel, external RAL 7032 painted and galvanised internal, interposed with 25 mm of high density polyurethane foam, having a sound reduction of $R_w = 40$ dB and thermal conductivity of 0,0247 W (m °K);
- Inspection door with lock system CE compliance, complete with handle
- UNEL-MEC asynchronous 3-phase motor 400V, class F insulation, IP55 protected
- Single speed as default, two speed version available on request.
- It complies with the essential requirements of Dir. 2006/42/CE for machinery and with the norms UNI EN ISO 13857 and 12499; CEI EN 60204 - 1.
- POSITIONING:** Floor mounting, Shelf mounting, Ceiling mounting

DATI TECNICI - TECHNICAL DATA

MODELLO	PORTATA	PA 100	PA 200	PA 300	PA 400	PA 500	PA 600	PA 700	PA 800	DB[A]
MODEL	FLOW RATE	PA 100	PA 200	PA 300	PA 400	PA 500	PA 600	PA 700	PA 800	DB[A]
	m³/h	RPM-kW	RPM-kW	RPM-kW	RPM-kW	RPM-kW	RPM-kW	RPM-kW	RPM-kW	min/max
CV-T 7/7	800	900-0,25	1260-0,25	-	-	-	-	-	-	50/53
	1000	955-0,25	1260-0,25	-	-	-	-	-	-	51/55
	1500	1068-0,25	1326-0,37	1555-0,55	1767-0,55	1958-0,75	-	-	-	57/65
	2000	-	1420-0,55	1672-0,55	1848-0,75	2068-0,75	-	-	-	63/69
CV-T 9/9	1500	700-0,25	1008-0,25	1260-0,55	-	-	-	-	-	51/60
	2000	714-0,25	1000-0,37	1250-0,55	1420-0,55	1566-0,75	1754-0,75	1958-1,1	-	54/70
	3000	-	1083-0,55	1278-0,55	1410-0,75	1566-1,1	1754-1,1	1848-1,5	2068-1,5	65/72
CV-T 10/10	2000	630-0,37	840-0,37	1068-0,55	1206-0,55	1410-0,75	1488-0,75	-	-	-
	3000	741-0,55	913-0,55	1083-0,55	1197-0,75	1336-1,1	1410-1,1	1568-1,5	1754-1,5	60/71
CV-T 12/12	4000	-	1015-0,75	1133-1,1	1269-1,1	1410-1,5	1494-1,5	1590-2,2	1679-2,2	70/75
	3000	504-0,37	741-0,55	913-0,55	-	-	-	-	-	50/60
	4000	562-0,55	710-0,55	906-0,75	1015-1,1	1195-1,5	-	-	-	57/68
	5000	571-0,55	746-0,75	906-1,1	1007-1,5	1128-1,5	1277-2,2	1353-2,2	1400-3	60/72
CV-T 15/15	6000	634-0,75	746-1,1	881-1,5	1007-1,5	1140-2,2	1277-2,2	1326-3	1400-3	65/75
	7000	705-1,1	793-1,5	939-2,2	1064-2,2	1125-3	1260-3	1326-3	-	68/75
	8000	-	840-2,2	939-2,2	1068-3	1189-3	1250-4	-	-	72/75
	6000	456-0,55	634-0,75	746-1,1	846-1,5	939-2,2	1064-2,2	1189-3	-	55/70
	7000	453-0,75	634-1,1	746-1,5	840-2,2	939-2,2	1068-3	1125-3	-	58/70
	8000	508-1,1	634-1,5	712-2,2	840-2,2	955-3	1068-3	1120-4	-	60/72
CV-T 18/18	9000	508-1,5	634-1,5	712-2,2	840-3	955-3	1081-4	1120-4	-	65/75
	10000	567-1,5	638-2,2	798-2,2	840-3	933-4	1061-4	1120-5,5	-	67/75
	12000	630-3	741-3	840-4	875-4	880-5,5	1045-5,5	-	-	72/75
	8000	360-0,55	508-1,1	634-1,5	712-2,2	840-2,2	-	-	-	58/69
	10000	403-1,1	508-1,5	638-2,2	712-2,2	840-3	875-4	1000-4	-	62/74
	12000	453-1,5	570-2,2	638-2,2	741-3	787-4	875-4	980-5,5	-	67/75
CV-T 18/18	14000	507-2,2	570-2,2	663-3	741-4	787-4	871-5,5	980-5,5	-	70/75
	16000	504-3	630-3	663-4	737-5,5	824-5,5	875-7,5	937-7,5	-	73/75

AMBITI APPLICATIVI

I ventilatori CV-T sono ideali per applicazioni professionali con alte prestazioni, dove è necessario installare una macchina assolutamente silenziosa, efficiente ed affidabile.

- Ospedali, cliniche, ambulatori;
- Centri commerciali;
- Uffici;
- Università, complessi scolastici;
- Mense aziendali, ristoranti;
- Hotel, residence, complessi abitativi.

ENVIRONMENTS APPLICATION

CV-T box fans are ideal for professional, high performance applications where an absolutely noiseless, efficient and reliable machine is required for installation

- Hospitals, clinics;
- Shopping centers;
- Offices;
- Universities, school buildings;
- Canteens, restaurants;
- Hotels, residences, housing estates

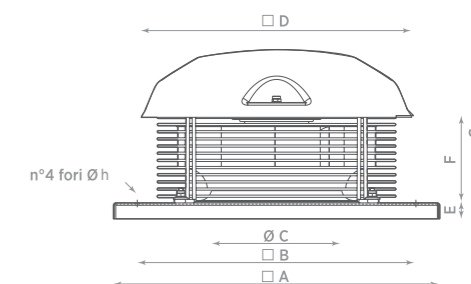
TXC**TORRINO - ROOF FAN**

MODELLO MODEL	A*A	B*B	ØC	D*D	E	F	G	Øh
TXC 301	310	260	140	340	212,5	107,5	20	5,5
TXC 302	310	260	140	340	212,5	107,5	20	5,5
TXC401	410	350	161	340	212,5	107,5	20	5,5
TXC 402	410	350	161	340	212,5	107,5	20	5,5

CE



Il più compatto. Ideale per strutture di media entità, convoglia all'esterno aria o esalazioni da condotti o direttamente dagli ambienti.

- Estrae aria/esalazioni provenienti da condotti o direttamente dall'ambiente;
- Indicato sia per l'ambito civile che industriale come ad esempio condomini, villette, uffici, ristoranti, palestre, piscine;
- L'elevata tecnologia del motore a statore rotante con cuscinetti a sfera classe B e protezione termica (IP44) ne garantisce una lunga durata;
- Temperatura max aria aspirata: 70°C (60°C per TXC 402);
- Temperatura di funzionamento -20°C +70°C (solo TXC 402 -20°C + 60°C);
- Estrema facilità d'installazione;
- Installabile su canne fumarie standard da 30x30 oppure 40x40 cm;
- Basso consumo energetico e ridotta rumorosità;
- Corpo in lamiera di acciaio zincato e cappello in materiale plastico;
- Griglia di protezione anti-infortunistica;
- Ventola centrifuga autopulente a pale rovesce;
- Velocità regolabile con l'utilizzo dei regolatori RGM 2 oppure RGE (opzionali);
- Conforme alle Direttive comunitarie in vigore ed alla NORMA EN 60335-2-80.
- **POSIZIONAMENTO:** a Tetto

The most compact. Ideal for small/medium sized structures.

- Centrifugal roof fan to extract air or fumes directly outside or through ducting;
- Suitable for domestic and industrial applications, such as block of flats, houses, offices, restaurants, gyms, swimming-pools;
- Motor impeller with external rotor, statically and dynamically balanced equipped with a ball bearing class B insulation motor, IP44 protected;
- IPX5 protected;
- Max temperature of extracted air: 70°C (model TXC 402 max. temp. 60°C);
- Fast and easy installation;
- Suitable to be installed on standard chimney flues 30x30 cm or 40x40 cm;
- Low energy consumption and reduced sound level;
- Zinc plated steel frame complete with plastic cover;
- Safety protection outside grille;
- Self-cleaning backward curved blade impeller;
- Adjustable speed through RGM2 or RGE controller (see accessories);
- In accordance with the essential requirements of the current European Directives and with European Standard EN 60335-2-80.
- **POSITIONING:** Roof mounting

DATI TECNICI - TECHNICAL DATA

MODELLO MODEL	CODICE CODE	MOTORE MOTOR	N° POLI N° POLES	GIRI AL MINUTO REV. PER MIN. (RPM)	TENSIONE VOLTAGE (Volt)	FREQUENZA FREQUENCY (Hz)	PORTATA FLOW RATE (m ³ /h)	PRESS. MAX. MAX PRESS. (mm H ₂ O)	PRESS. MAX. MAX PRESS. (Pa)	POTENZA POWER (W)	CORR. NOM. NOM. CURR. (A)	IP MOTORE IP MOTOR	RUMOROSITÀ NOISE dB(A) _{1m}	PESO WEIGHT (Kg)
TXC 301	0040600	single p.	2	2400	230	50/60	500	31	302	50	0,25	IP44	52	4,6
TXC 302	0040700	single p.	2	2600	230	50/60	780	39	383	65	0,33	IP44	53	4,6
TXC 401	0040800	single p.	2	2600	230	50/60	1000	39	383	65	0,33	IP44	52	5,8
TXC 402	0040900	single p.	2	2600	230	50/60	1550	66	650	145	0,7	IP44	57	6,7

AMBITI APPLICATIVI

Indicato per ambito civile, commerciale, terziario e industriale come ad esempio:

- Condomini;
- villette;
- Uffici;
- Ristoranti;
- Negozi;
- Palestre;
- Piscine;
- Industrie;
- Macchinari.

ENVIRONMENTS APPLICATION

Suitable for installation in Commercial, industrial and tertiary environment:

- Apartments building;
- Villas;
- Offices;
- Restaurants;
- Shops;
- Gyms;
- Swimmipools;
- Factories;
- Machinery.

ACCESSORI DISPONIBILI SU RICHIESTA - ACCESSORIES AVAILABLE ON DEMAND

Giunto antivibrante
flangiato
Anti-vibration flanged joint

Tronchetto di espulsione
con rete di protezione
Outlet connection
with protection grille

Tronchetto porta filtri
Carrying filters
connection

Piedini di appoggio
Rubber feet

Tetto parapioggia
Rain cover

GRAFICI DI PORTATA - FLOW CHARTS

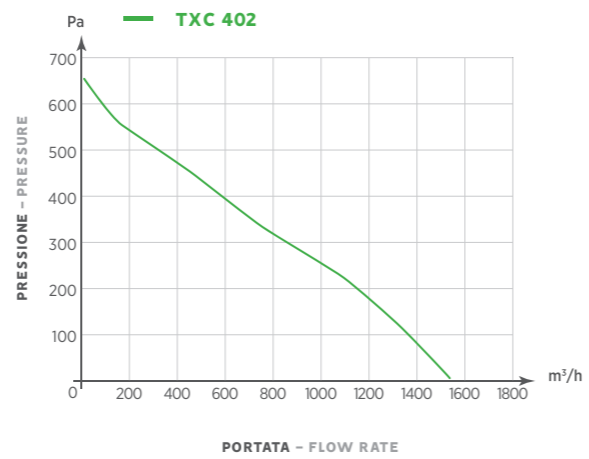
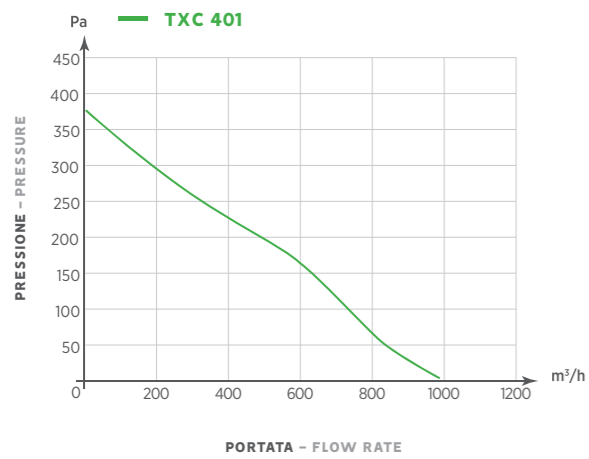
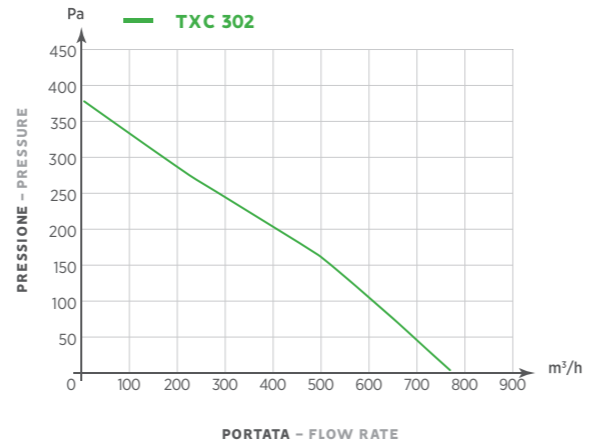
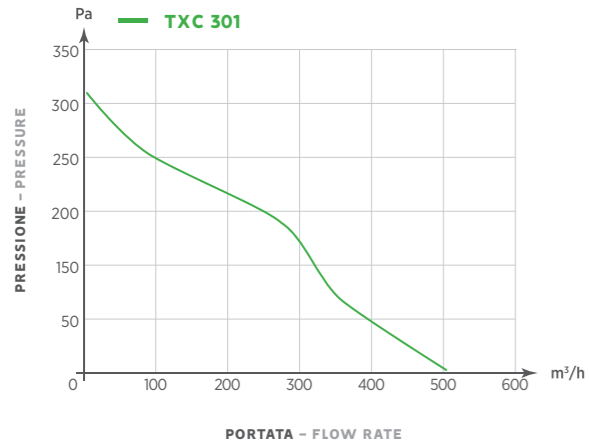

ACCESSORI (PAGINA 72) - ACCESSORIES (PAGE 72)



Regolatori
Controllers

TXP

TORRINO - ROOF FAN

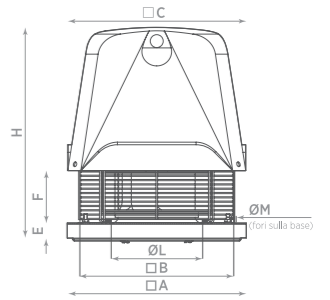

MODELLO MODEL	A*A	B*B	C*C	E	F	H	ØL	ØM
TXP 3	400	350	412	40	135	493	200	11,2
TXP 6	400	350	412	40	135	493	250	11,2
TXP 7	560	460	560	40	240	608	350	11,2
TXP 8	560	460	560	40	240	608	350	11,2
TXP 10	710	610	740	40	253	638	400	11,2
TXP 12	900	800	950	40	305	910	500	11,2
TXP 14	900	800	950	45	300	910	550	11,2
TXP 15	900	800	950	45	300	910	600	11,2
TXP 18	900	800	950	45	300	910	600	11,2



- Il più potente fra i torrini, gestisce portate d'aria medio alte con pressioni che superano le perdite di carico di lunghi condotti.
- Estrae aria/esalazioni provenienti da condotti o direttamente dall'ambiente;
- Portate d'aria medio-alte con pressioni in grado di superare notevoli perdite di carico dovute alle resistenze dei condotti;
- Prodotto di lunga durata grazie all'utilizzo di un motore a induzione con cuscinetti a sfera e protezione IP55, isolamento in classe F e ventola per autoraffreddamento;
- Ventola centrifuga autopulente a pale rovesce in lamiera d'acciaio zincato equilibrata staticamente e dinamicamente;
- Corpo e ventola in lamiera d'acciaio zincato, cappello in materiale plastico;
- Griglia di protezione anti-infortunistica;
- Temperatura max aria aspirata: 60°C;
- Alcuni modelli possono essere regolati in velocità tramite l'utilizzo dei regolatori serie RGM /RGT (opz.);
- Conforme alle direttive comunitarie in vigore ed alle NORME: UNI EN ISO 13857; UNI EN ISO 12499; CEI EN 60204-1.
- POSIZIONAMENTO:** a Tetto

- The most powerful. Ideal for medium/large sized structures.
- Centrifugal roof fans with horizontal outlet to extract air or fumes directly outside or through ducts;
- Medium-high flow rates to overcome pressure losses due to duct resistance;
- Ball bearing class F insulation motor IP55 protected;
- Zinc-plated steel frame and impeller, cover made of plastic material;
- Safety protection outside grille;
- Self-cleaning backward curved blade impeller, statically and dynamically balanced;
- Some models can be regulated through RGM or RGT controllers (see accessories);
- Max temperature of extracted air: 60°C;
- In accordance with the essential requirements of 2006/42/EC Directive concerning machines and European Standards UNI EN ISO 13857; UNI EN ISO 12499; CEI EN 60204-1.
- POSITIONING:** Roof mounting

DATI TECNICI - TECHNICAL DATA

MODELLO MODEL	CODICE CODE	MOTORE MOTOR	N° POLI N° POLES	GIRI AL MINUTO REV. PER MIN.	TENSIONE VOLTAGE	FREQUENZA FREQUENCY	PORTATA FLOW RATE	PRESS. MAX MAX PRESS.	PRESS. MAX MAX PRESS.	POTENZA POWER	CORR. NOM.(A) NOM. CORR.	IP MOTORE IP MOTOR	RUMOROSITÀ NOISE	PESO WEIGHT
				(RPM)	(Volt)	(Hz)	(m³/h)	(mm H₂O)	(Pa)	(W)	230V 400V		dB(A) _{1m}	(kg)
TXP 3M	0074100	single p.	4	1400	230	50	1200	20	196	120	0,81 -	IP55	60	14
TXP 6M	0074200	single p.	4	1400	230	50	1800	30	294	180	1,05 -	IP55	66	18
TXP 7M	0074300	single p.	4	1400	230	50	3100	40	392	250	1,40 -	IP55	69	25
TXP 8M	0074400	single p.	4	1400	230	50	4200	45	441	370	1,90 -	IP55	70	30
TXP 10M	0074500	single p.	4	1400	230	50	5700	56	549	750	3,40 -	IP55	75	40
TXP 3T	0074600	three p.	4	1400	230/400	50	1200	20	196	120	0,81 0,47	IP55	60	14
TXP 6T	0074700	three p.	4	1400	230/400	50	1800	30	294	180	1,05 0,60	IP55	66	18
TXP 7T	0074800	three p.	4	1400	230/400	50	3100	40	392	250	1,42 0,82	IP55	69	25
TXP 8T	0074900	three p.	4	1400	230/400	50	4200	45	441	370	1,90 1,10	IP55	70	30
TXP 10T	0075000	three p.	4	1400	230/400	50	5700	56	549	750	3,4 1,8	IP55	75	40
TXP 12T	0075100	three p.	6	900	230/400	50	7100	39	382	750	3,81 2,20	IP55	71	57
TXP 14T	0075200	three p.	6	900	230/400	50	10800	48	471	1100	5,37 3,10	IP55	75	76
TXP 15T	0075400	three p.	6	900	230/400	50	14200	57	559	2200	9,35 5,40	IP55	80	96
TXP 18T	0075500	three p.	6	900	230/400	50	18800	65	637	3000	11,95 6,90	IP55	84	110

AMBITI APPLICATIVI

Indicato sia in ambito industriale che civile come cucine di mense e ristoranti, impianti sportivi, supermercati e centri commerciali, industrie, depositi, uffici, servizi igienici, condomini.

ENVIRONMENTS APPLICATION

Suitable for both industrial and civil application, such as canteens, restaurants, sports facilities, supermarkets and shopping centers, factories, warehouse, offices, toilets and apartment buildings

GRAFICI DI PORTATA - FLOW CHARTS

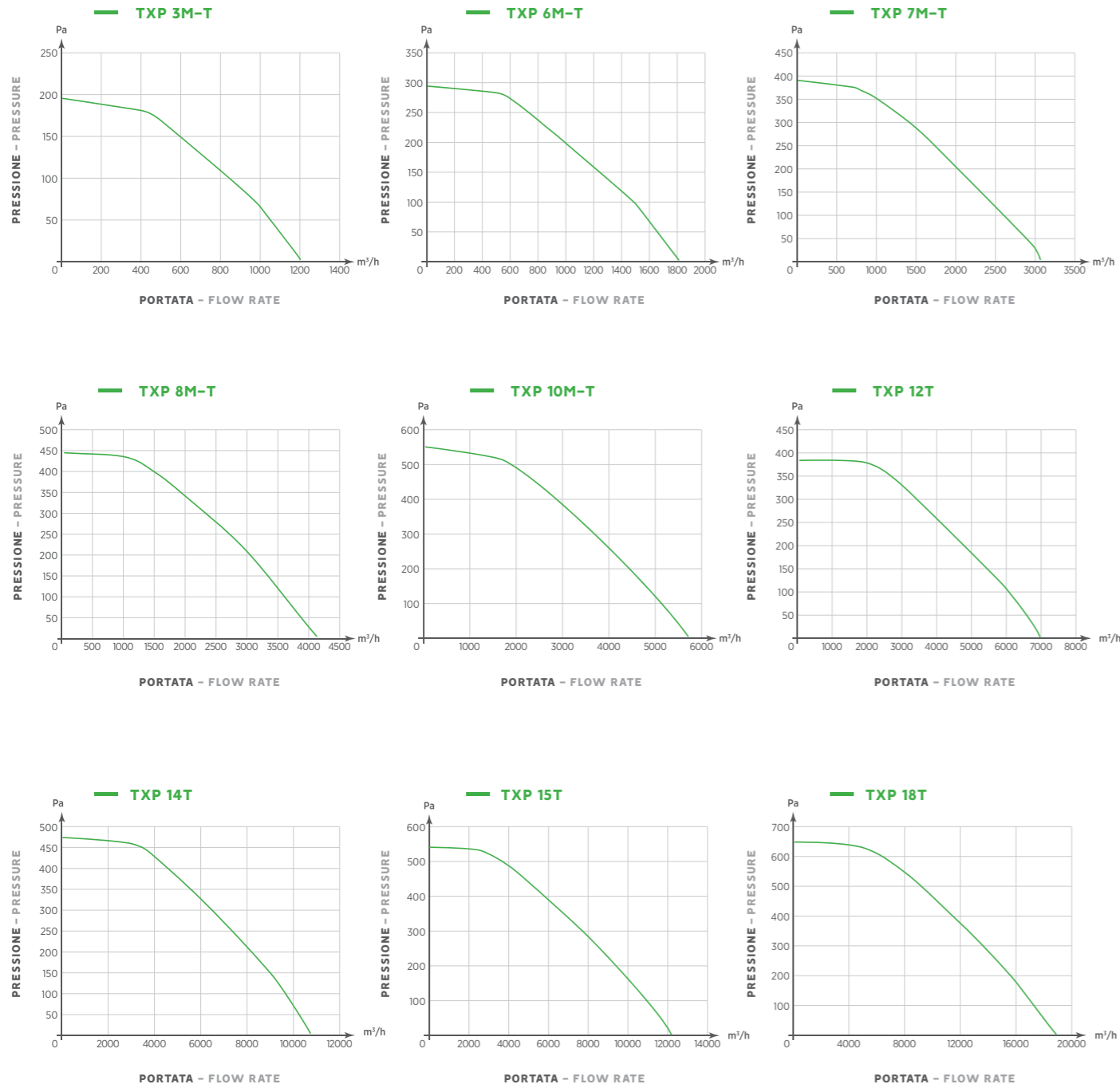

ACCESSORI (PAGINA 72, 74) - ACCESSORIES (PAGE 72, 74)



Regolatori Controllers Controtelaio di base Frame base Serranda a gravità Gravity shutter

TXV

TORRINO - ROOF FAN

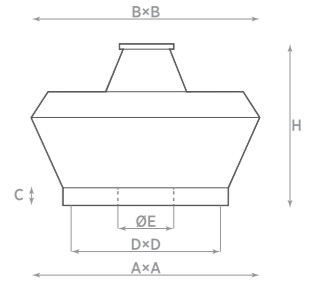

MODELLO MODEL	A×A	B×B	C	D×D	ØE	H
TXV 3	400	590	40	350	200	480
TXV 6	400	590	40	350	250	500
TXV 7	560	780	40	460	300	630
TXV 8	560	780	40	460	350	630
TXV 10	710	930	40	610	400	700
TXV 12	900	1210	40	800	500	780
TXV 14	900	1210	45	800	550	820
TXV 15	900	1210	45	800	600	860
TXV 18	900	1210	45	800	600	900



- La potenza a scarico verticale. Il getto verticale evita che l'aria estratta si scarichi su componenti o muri adiacenti al prodotto.
- Estrae aria o esalazioni provenienti da condotti o ripresi direttamente dall'ambiente;
- Scarico dell'aria verticale;
- Temperatura max aria aspirata: 60°C;
- Motore su cuscinetti a sfera per una lunga durata;
- Grado protezione motore IP55, isolamento classe F;
- Corpo e convogliatore in lamiera d'acciaio zincato;
- Ventola centrifuga autopulente a pale rovesce;
- Griglia di protezione anti-infortunistica;
- Adatto sia in ambito industriale che civile come cucine di mense e ristoranti, impianti sportivi, supermercati e centri commerciali, industrie, depositi, uffici, servizi igienici, condomini;
- Alcuni modelli regolabili in velocità tramite l'utilizzo dei regolatori RGM/RGT (opzionali);
- Conforme alle Direttive comunitarie in vigore ed alle Norme: UNI EN ISO 13587; UNI EN ISO 12499; CEI EN 60204-1.
- POSIZIONAMENTO:** a Tetto

- The most powerful with vertical outlet. Ideal for medium/large sized structures.
- Centrifugal roof fans to extract air or fumes directly outside or through ducts;
- The vertical extracted air avoids to stain the lateral walls or components;
- Medium-high flow rates to overcome pressure losses due to duct resistance;
- Suitable for industrial and domestic environment: refectory kitchens and restaurants, sports facilities, shopping centres, industries, deposits, offices, toilets, apartments;
- Ball bearing class F insulation motor IP55 protected;
- Max temperature of extracted air: 60°C;
- Easy installation;
- Case in galvanized sheet steel;
- Safety protection outside grille;
- Self cleaning backward centrifugal impeller;
- Some models can be regulated through RGM or RGT controllers (see accessories);
- In accordance with the essential requirements of 2006/42/EC Directive concerning machines and European Standards UNI EN ISO 13587; UNI EN ISO 12499; CEI EN 60204-1.
- POSITIONING:** Roof mounting

DATI TECNICI - TECHNICAL DATA

MODELLO MODEL	CODICE CODE	MOTORE MOTOR	N° POLI N° POLES	GIRI AL MINUTO REV. PER MIN. (RPM)	TENSIONE VOLTAGE (Volt)	FREQUENZA FREQUENCY (Hz)	PORTATA FLOW RATE (m³/h)	PRESS. MAX MAX PRESS. (mm H ₂ O)	PRESS. MAX MAX PRESS. (Pa)	POTENZA POWER (W)	CORR. NOM. (A) NOM. CORR. 230V 400V	IP MOTORE IP MOTOR	RUMOROSITÀ NOISE dB(A) _{1m}	PESO WEIGHT (kg)
TXV 3M	0074120	single p.	4	1400	230	50	1200	20	196	120	0,81 -	IP55	60	20
TXV 6M	0074220	single p.	4	1400	230	50	1800	30	294	180	1,05 -	IP55	66	26
TXV 7M	0074320	single p.	4	1400	230	50	3100	40	392	250	1,4 -	IP55	69	35
TXV 8M	0074420	single p.	4	1400	230	50	4200	45	441	370	1,9 -	IP55	70	42
TXV 10M	0074520	single p.	4	1400	230	50	5700	56	549	750	3,4 -	IP55	75	55
TXV 3T	0074620	three p.	4	1400	230/400	50	1200	20	196	120	0,81 0,47	IP55	60	20
TXV 6T	0074720	three p.	4	1400	230/400	50	1800	30	294	180	1,05 0,6	IP55	66	26
TXV 7T	0074820	three p.	4	1400	230/400	50	3100	40	392	250	1,42 0,82	IP55	69	35
TXV 8T	0074920	three p.	4	1400	230/400	50	4200	45	441	370	1,9 1,1	IP55	70	42
TXV 10T	0075020	three p.	4	1400	230/400	50	5700	56	549	750	3,4 1,8	IP55	75	55
TXV 12T	0075120	three p.	6	900	230/400	50	7100	39	382	750	3,81 2,2	IP55	71	77
TXV 14T	0075220	three p.	6	900	230/400	50	10800	48	471	1100	5,37 3,1	IP55	75	100
TXV 15T	0075420	three p.	6	900	230/400	50	14200	57	559	2200	9,35 5,4	IP55	80	122
TXV 18T	0075520	three p.	6	900	230/400	50	18800	65	637	3000	11,95 6,90	IP55	84	138

AMBITI APPLICATIVI

- Indicato sia in ambito industriale che civile come:
- Cucine di mense e ristoranti;
- Impianti sportivi;
- Supermercati e centri commerciali;
- Industrie;
- Depositi;
- Uffici;
- Servizi igienici;
- Condomini.

ENVIRONMENTS APPLICATION

- Suitable for both industrial and civil application, such as:
- Canteens;
- Restaurants;
- Sports facilities;
- Supermarkets and shopping centers;
- Factories;
- Warehouse;
- Offices;
- Toilets and apartment buildings

GRAFICI DI PORTATA - FLOW CHARTS

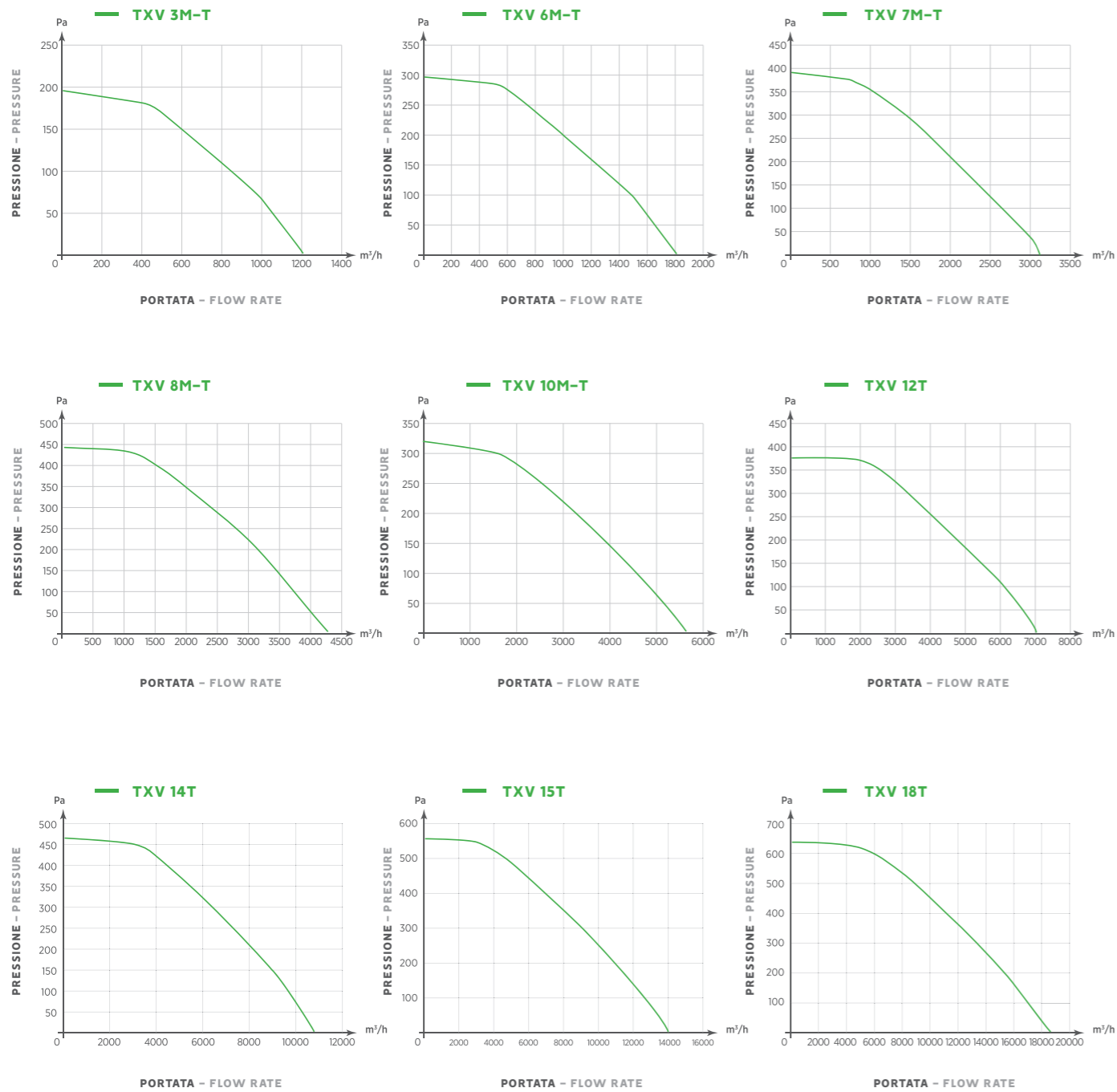

ACCESSORI (PAGINA 72, 74) - ACCESSORIES (PAGE 72, 74)



Regolatori Controllers
 Controtelaio di base Frame base
 Serranda a gravità Gravity shutter

TXA

TORRINI ASSIALI - ROOF FANS

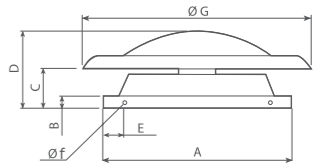

MODELLO MODEL	A	B	C	D	E	Øf	G
TXA 40 4T	660	45	138	300	100	12	710
TXA 50 4T	760	50	160	345	100	12	875
TXA 63 4T	890	55	185	362	100	12	1120
TXA 71 6T	950	50	155	409	100	12	1300
TXA 80 6T	1230	50	313	518	185	12	1300
TXA 100 6T	1400	50	335	600	170	12	1600



- Torrini assiali a scarico orizzontale.
- Estrae aria o esalazioni provenienti direttamente dall'ambiente o da brevissimi condotti;
- Portate d'aria elevate con pressioni relativamente basse;
- Indicato per installazione prevalentemente in ambito industriale soprattutto in tutti quegli ambienti dove è necessario aspirare grandi volumi d'aria in assenza di condotti, ad esempio magazzini, capannoni, parcheggi, serre ed allevamenti, impianti sportivi, supermercati e centri commerciali, industrie;
- Prodotto di lunga durata, motore asincrono con grado di protezione IP55, isolamento in classe F;
- Temperatura max aria aspirata: 50°C;
- Estrema facilità d'installazione;
- Corpo e convogliatore in lamiera di acciaio zincato, cappello di protezione in policarbonato. Dotato di golfari per il sollevamento;
- Griglia di protezione anti-infortunistica;
- Possibilità di doppia velocità tramite commutazione stella/triangolo;
- Reversibilità del flusso d'aria
- Ventola equilibrata con pale in alluminio ad alto rendimento;
- Conforme alle direttive comunitarie in vigore ed alle NORME UNI EN ISO 13587; UNI EN ISO 12499; CEI EN 60204-1.
- POSIZIONAMENTO:** a Tetto

- UK** Axial roof fans with horizontal outlet. Ideal for medium/large sized structures.
- Axial roof fans to extract air or fumes directly outside or through ducts;
- High flow rates with low pressures;
- Suitable for industrial environments where is required to extract a big volume of air without ducts such as: warehouses, sheds, parking, greenhouses and breeding, sports facilities, supermarkets and commercial centres, industries;
- Ball bearing class F insulation motor IP55 protected;
- Max temperature of extracted air: 50°C;
- Easy installation;
- Case and air conveyor in galvanized steel sheet, cover protection in fibreglass RAL 7038 coloured, equipped with eyebolts for lifting;
- Safety protection outside grille;
- Double speed through switching star/delta;
- In accordance with the essential requirements of 2006/42/EC Directive concerning machines and European Standards UNI EN ISO 13857; UNI EN ISO 12499; CEI EN 60204-1.
- POSITIONING:** Roof mounting

DATI TECNICI - TECHNICAL DATA

MODELLO MODEL	CODICE CODE	MOTORE MOTOR	N° POLI N° POLES	GIRI AL MINUTO REV. PER MIN. (RPM)	TENSIONE VOLTAGE (Volt)	FREQUENZA FREQUENCY (Hz)	PORTATA FLOW RATE (m³/h)	POTENZA POWER (W)	CORR. NOM. NOM. CURR. 400V (A)	IP MOTORE IP MOTOR	RUMOROSITÀ NOISE dB(A) _{1m}	PESO WEIGHT (kg)
TXA 40 4T	0055010	three p.	4	900/1400	400	50/60	2900/3850	110/220	0,22/0,59	IP55	49/56	17
TXA 50 4T	0055020	three p.	4	900/1400	400	50/60	6250/7750	370/540	0,61/1,14	IP55	59/62	25
TXA 63 4T	0055030	three p.	4	900/1400	400	50/60	11900/13700	710/930	0,56/1,95	IP55	63/67	34
TXA 71 6T	0055040	three p.	6	700/900	400	50/60	10100/13200	520/850	0,85/1,73	IP55	57/63	47
TXA 80 6T	0055050	three p.	6	700/900	400	50/60	20300/23700	1300/1700	2,16/4,17	IP55	67/61	62
TXA 100 6T	0055060	three p.	6	700/900	400	50/60	26100/35500	1850/3800	3,8/8,2	IP55	66/73	90

AMBITI APPLICATIVI

- Indicato per installazione in ambito industriale:
- Magazzini;
- Capannoni;
- Parcheggi;
- Serre ed allevamenti;
- Impianti sportivi;
- Supermercati e centri commerciali;
- Industrie.

ENVIRONMENTS APPLICATION

- UK** Suitable for Industrial application:
- Warehouse;
- Industrial buildings;
- Car garages;
- Greenhouses and breedings;
- Sport facilities;
- Supermarkets and Shopping centers;
- Factories.

GRAFICI DI PORTATA - FLOW CHARTS

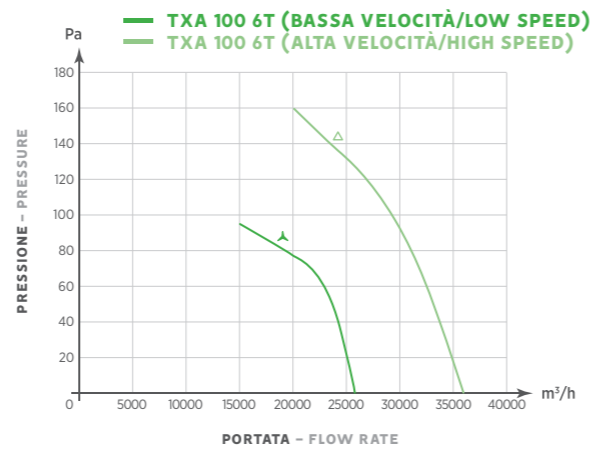
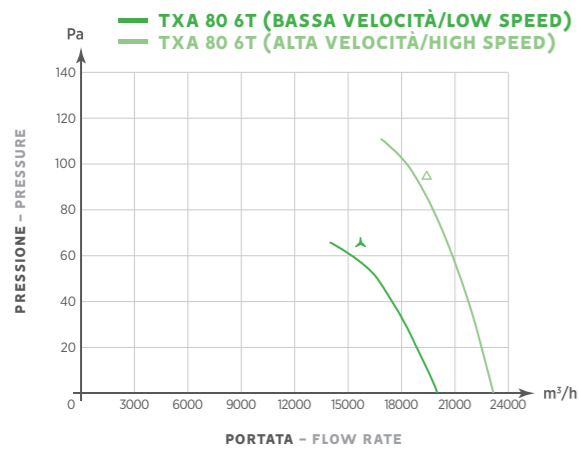
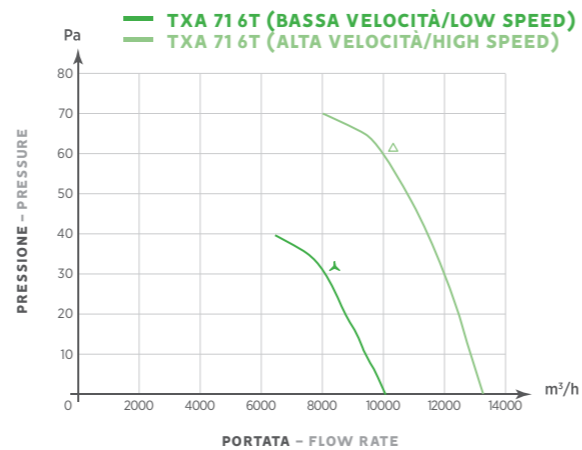
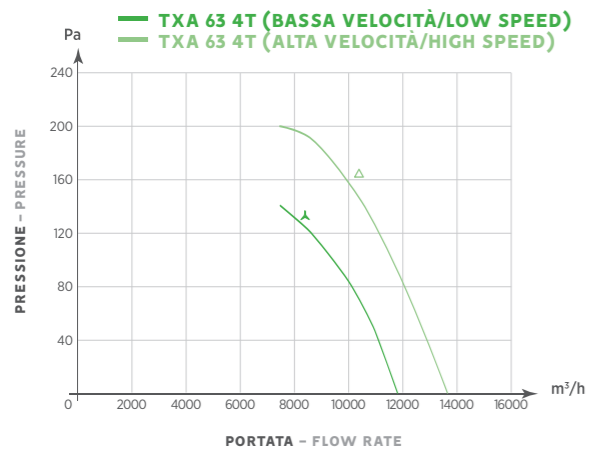
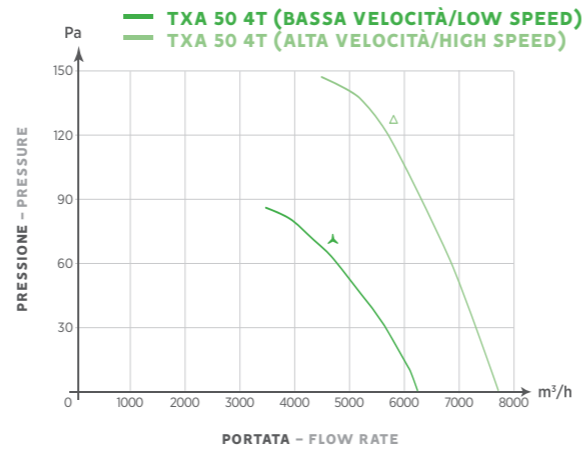
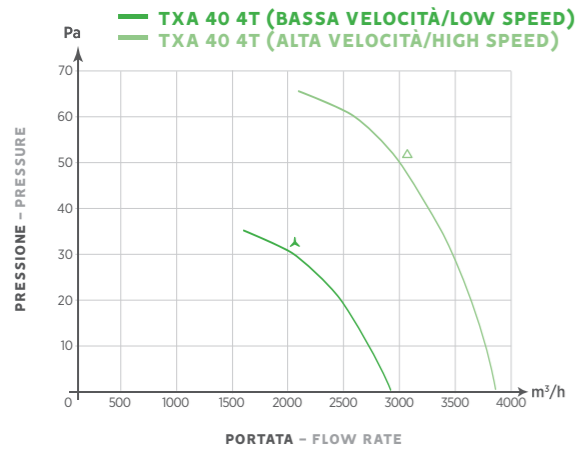

ACCESSORI (PAGINA 74) - ACCESSORIES (PAGE 74)

Serranda a gravità
Gravity shutter

TURBOCAMINO

TORRINO PER CAMINI A 200°C - ROOF FAN FOR 200°C

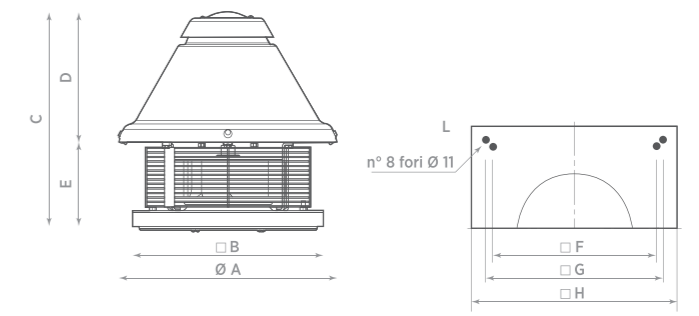

MODELLO	Ø A	B	C	D	E	F	G	H	Ø L
TURBOCAMINO	475	415	470	286	184	330	357	415	11



- Nato per le alte temperature (max 200°C). Specifico per camini a legna, forni e cappe industriali.
- Espelle all'esterno aria/fumi caldi anche in presenza di agenti polverosi;
- Particolari tecnologie costruttive lo rendono adatto all'estrazione di fumi con temperatura max. di 200°C;
- Indicato per tutti i camini con basso tiraggio naturale;
- Motore con grado di protezione IP55, dotato di cuscinetti a sfera e ventola di raffreddamento per una lunga durata;
- Copertura in alluminio resistente agli agenti atmosferici;
- Ventola centrifuga autopulente a pale rovesce in lamiera d'acciaio zincato equilibrata staticamente e dinamicamente;
- Griglia di protezione anti-infortunistica;
- Controtelaio zincato di fissaggio in dotazione;
- Regolatore elettronico di velocità RGE già fornito con il prodotto. Per uso industriale è disponibile il regolatore RGM2 (opzionale);
- Conforme alle direttive comunitarie in vigore ed alle NORME UNI EN ISO 13857; UNI EN ISO 12499; CEI EN 60204-1.
- POSIZIONAMENTO:** a Tetto

- Centrifugal chimney roof fans for hot fumes (max 200°C). To extract hot dusty fumes/air smoke at temperature up to 200°C;
- Suitable for fireplaces, ovens waste or industrial hoods;
- For all chimneys with low natural draw;
- Ball bearing class F insulation motor IP55 protected;
- Aluminium protection cover;
- Self cleaning backward centrifugal zinc plated steel impeller statically and dynamically balanced;
- Safety protection outside grille;
- Provided with electronic speed controller RGE, for industrial use RGM2 available as accessory;
- The opening system allows easy access to the chimney for cleaning;
- In accordance with the essential requirements of 2006/42/EC Directive concerning machines and European Standards UNI EN ISO 13857; UNI EN ISO 12499; CEI EN 60204-1.
- POSITIONING:** Roof mounting

DATI TECNICI - TECHNICAL DATA

MODELLO	CODICE	MOTORE	N° POLI	GIRI AL MINUTO	TENSIONE	FREQUENZA	PORTATA	PRESS. MAX	PRESS. MAX	POTENZA	CORR. NOM. (A)	IP MOTORE	RUMOROSITÀ	PESO
MODEL	CODE	MOTOR	N° POLES	REV. PER MIN. (RPM)	VOLTAGE (Volt)	FREQUENCY (Hz)	FLOW RATE (m³/h)	MAX PRESS. (mm H ₂ O)	MAX PRESS. (Pa)	POWER (W)	NOM. CURR. 230V	IP MOTOR	NOISE db(A) _{1m}	WEIGHT (Kg)
TURBOCAMINO	0055400	single p.	4	1400	230	50/60	1200	19,5	191	110	0,6	IP55	52,5	13,2

AMBITI APPLICATIVI

Indicato per tutti i camini con basso tiraggio naturale.

PER APPROFONDIRE - FURTHER INFORMATION



L'apertura a compasso facilita l'accesso alla canna fumaria
Compass opening for easy access to the chimney.

ACCESSORI (PAGINA 72) - ACCESSORIES (PAGE 72)



Regolatori
Controllers

ENVIRONMENTS APPLICATION

Suitable for all chimneys with insufficient up draught.

GRAFICI DI PORTATA - FLOW CHARTS

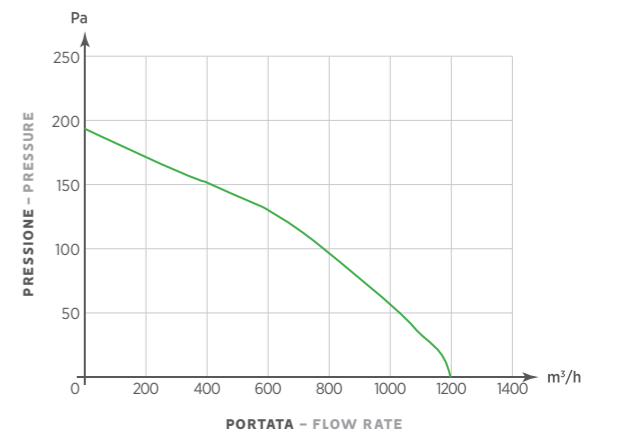

ANTIDEFAGRANTI EX-ATEX – EXPLOSION PROOF FANS EX-ATEX

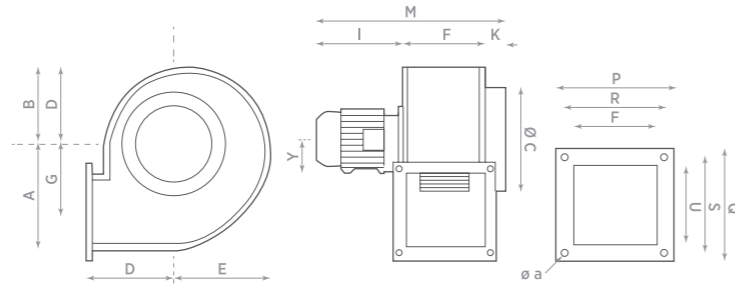

MODELLO	A	B	ØC	D	E	F	G	Y	K	I	M	P	Q	R	S	T	U	Øa	*Z
MODEL																			
CB 230 EX-ATEX	139	108	180	127	122	94	91	63	42	242	378	135	135	114	114	88	90	8,2	4
CB 240 EX-ATEX	172	128	200	146	150	112	117	63	45	242	399	152	152	126	126	105	105	8,2	4

*Z: n° Fori/Holes



Aspiratori centrifughi destinati all'utilizzo in atmosfera potenzialmente esplosiva (Direttiva ATEX 2014/34/UE nei paesi membri della Comunità Europea).

- Ideali per ambito industriale in presenza di gas, vapori e nebbie infiammabili;
- Omologato con certificato CESI n° 03 ATEX 250;
- Espulsione dell'aria in condotti medio-lunghi;
- Aspiratore gruppo II, categoria 2 per gas, sicurezza costruttiva Ex h, livello protezione apparecchio (EPL) Gb, max temp. superficiale T4 (135°C); a richiesta modelli T5 e T6
- Utilizzabile in aree classificate come zona 1 e 2;
- Ventola e Corpo in lamiera d'acciaio. Corpo verniciato a forno con polveri epossidiche anticorrosione
- Motore tipo Exd IIC T4 su cuscinetto a sfera classe F con grado di protezione IP55;
- Temp. max aria aspirata: 60°C;
- Il prodotto standard viene fornito con la coclea in posizione CCW 270;
- Su richiesta possono essere fornite posizioni della coclea e senso di rotazione diversi, come indicato nella tabella a pag. 77;
- Normative di riferimento: EN 80079-36; EN 80079-37; EN 14986.
- **POSIZIONAMENTO:** a Parete

Explosion Proof Certified Centrifugal fans to extract air and fumes through medium/long sized ducts in compliance with ATEX Directive 2014/34/UE.

- Suitable for applications in commercial and industrial environments where the risk of explosion is high and where the surrounding atmosphere contains gas, vapours or highly inflammable steam;
- The whole product and not just the electrical parts, has been certified by CESI Institute with CESI n° 03 ATEX 250;
- Fan group II, cat. 2 for gases, construction safety Ex h, device protection level (EPL) Gb, max surface temp. T4 (135°C), available on demand T5 and/or T6;
- Classified for zones 1 and 2;
- This approval homologation has required specific safety tests and proper examinations on products to verify how the adopted solutions have satisfied the essential Directive requirements;
- Steel plated frame protected by an epoxy-based anticorrosive paint and aluminium centrifugal impeller statically and dynamically balanced;
- Exd IIC T4, ball bearing class F insulation motor IP55 protected;
- Max temperature of extracted air: 60°C;
- Standard product supplied with impeller housing position CCW 270, different positions available on request (see table on page 78);
- Reference Standards: EN 80079-36; EN 80079-37; EN 14986.
- **POSITIONING:** Wall mounting

DATI TECNICI – TECHNICAL DATA

MODELLO	CODICE	MOTORE	MARCATURA	N° POLI	GIRI/MINUTO	TENSIONE	FREQUENZA	PORTATA	PRESS. MAX	PRESS. MAX	POTENZA	CORR. NOM. (A)	IP MOTORE	RUMOROSITÀ	PESO	
MODEL	CODE	MOTOR	MARKING	N° POLES	REV. PER MIN.	VOLTAGE	FREQUENCY	FLOW RATE	MAX PRESS.	MAX PRESS.	POWER	NOM. CURR.	IP MOTOR	NOISE	WEIGHT	
EX-ATEX					(RPM)	(Volt)	(Hz)	(m³/h)	(mm H ₂ O)	(Pa)	(W)	230V 400V		dB(A) _{1m}	(kg)	
CB 230 2M	0032300	single p.	II 2GExh T4	2	2750	230	50	1000	69	677	450	2,5	-	IP55	76	10
CB 240 2M	0032400	single p.	II 2GExh T4	2	2800	230	50	1450	90	883	850	3,8	-	IP55	83	12
CB 230 2T	0031900	three p.	II 2GExh T4	2	2750	230/400	50	1000	69	677	400	1,4	0,8	IP55	76	10
CB 240 2T	0032000	three p.	II 2GExh T4	2	2800	230/400	50	1450	90	883	800	2,3	1,3	IP55	83	12

AMBITI APPLICATIVI

Indicato per installazione in ambito commerciale, terziario e industriale. Destinati all'utilizzo in atmosfera potenzialmente esplosiva:

- Negozi;
- Officine;
- Impianti sportivi;
- Supermercati e centri commerciali;
- Depositi e magazzini;
- Industrie;
- Macchinari

ENVIRONMENTS APPLICATION

suitable for Industrial, civil and commercial application where the risk of explosion is high.

- Shops;
- Workshops;
- Sports facilities;
- Supermarkets and shopping centers;
- Warehouse;
- Factories;
- Machinery.

GRAFICI DI PORTATA – FLOW CHARTS

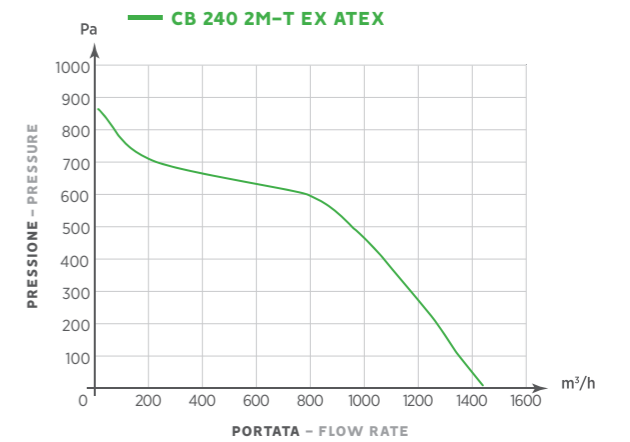
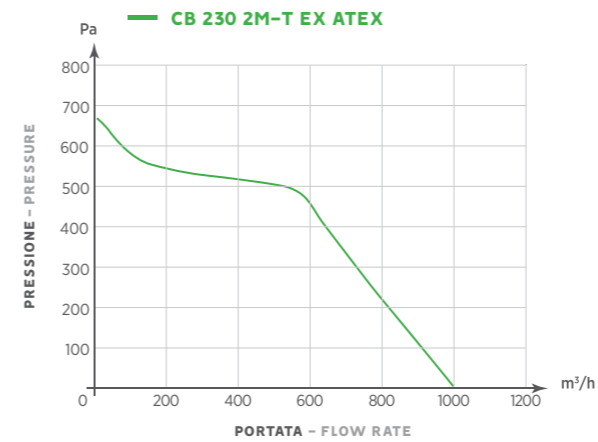

ACCESSORI INSTALLABILI FUORI ZONA EX ATEX (PAGINA 72) ACCESSORIES SUITABLE FOR INSTALLATION OUTSIDE OF THE EX ATEX AREA (PAGE 72)



Regolatori
Controllers

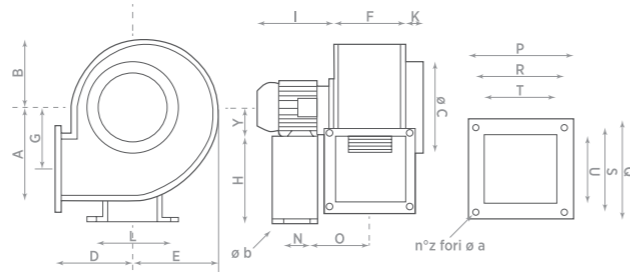

MODELLO	A	B	ØC	D	E	F	G	H	Y	K	I	L	N	O	P	Q	R	S	T	U	*Z	Øa	Øb
CS 310	139	108	180	127	122	94	91	-	63	42	242	-	-	-	135	135	114	114	88	90	4	8,2	-
CS 320	172	128	200	146	150	112	117	-	63	45	242	-	-	-	152	152	126	126	105	105	4	8,2	-
CS 330	209	163	250	147	188	141	139	-	71	40	242	-	-	-	191	191	165	165	134	134	4	8,2	-
CS 340	250	194	250	178	222	164	162	-	80	45	259	-	-	-	225	235	195	205	161	170	4	8,2	-
CS 350	290	225	315	210	260	194	192	245	80	50	259	232	120	149	255	255	225	225	191	194	4	8,2	11
CS 360	290	225	315	210	260	194	192	245	90	50	300	232	120	155	255	255	225	225	191	194	4	8,2	11
CS 370	334	244	355	230	250	221	210	350	100	50	354	325	170	173	284	305	254	275	213	244	4	10,2	11
CS 380	429	315	400	300	370	249	280	350	112	62	358	325	170	194	310	360	280	330	241	295	8	9	11

*Z: n° Fori/Holes



Aspiratori centrifughi destinati all'utilizzo in atmosfera potenzialmente esplosiva (Direttiva ATEX 2014/34/UE nei paesi membri della Comunità Europea).

- Ideali per ambito industriale in presenza di gas, vapori e nebbie infiammabili.
- Omologato con certificato CESI n° 03 ATEX 250;
- Espulsione dell'aria in condotti medio-lunghi;
- Aspiratore gruppo II, categoria 2 per gas, sicurezza costruttiva Ex h, livello protezione apparecchio (EPL) Gb, max temp. superficiale T4 (135°C); a richiesta modelli T5 e T6;
- Utilizzabile in aree classificate come zona 1 e 2;
- Ventola e Corpo in lamiera d'acciaio. Corpo verniciato a forno con polveri epossidiche anticorrosive;
- Motore tipo Exd IIC T4 su cuscinetto a sfera classe F con grado di protezione IP55;
- Temp. max aria aspirata: 60°C;
- Il prodotto standard viene fornito con la coclea in posizione CCW 270°;
- Su richiesta possono essere fornite posizioni della coclea e senso di rotazione diversi, come indicato nella tabella a pag. 77;
- A partire dal modello 350, i prodotti sono dotati di supporto rigido (sedia) per facilitarne l'installazione;
- Normative di riferimento: EN 80079-36; EN 80079-37; EN 14986.
- **POSIZIONAMENTO:** a Parete

Explosion Proof Certified Centrifugal fans to extract air and fumes through medium/long sized ducts in compliance with ATEX Directive 2014/34/UE.

- Suitable for applications in commercial and industrial environments where the risk of explosion is high and where the surrounding atmosphere contains gas, vapours or highly inflammable steam;
- The whole product and not just the electrical parts, has been certified by CESI institute with CESI n°03 ATEX 250 certificate;
- Fan group II, cat. 2 for gases, construction safety Ex h, device protection level (EPL) Gb, max surface temp. T3 (200°C);
- Classified for zones 1 and 2;
- This approval has required specific safety tests and proper examinations on products to verify how the adopted solutions have satisfied the essential Directive requirements;
- Steel plated frame protected by an epoxy-based anticorrosive paint and aluminium centrifugal impeller statically and dynamically balanced;
- Exd IIC T4, ball bearing class F insulation motor IP55 protected;
- Max temperature of extracted air: 60°C;
- Models CS 350, 360, 370 and 380: mounted on rigid base support to make installation easier;
- Standard product supplied with impeller housing position CCW 270°, different positions available on request (see table on page 78);
- Reference Standards: EN 80079-36; EN 80079-37; EN 14986.
- **POSITONING:** Wall mounting

DATI TECNICI - TECHNICAL DATA

MODELLO	CODICE	MOTORE	MARCATURA	N° POLI	GIRI/ALMINUTO	TENSIONE	FREQUENZA	PORTATA	PRESS.MAX	PRESS.MAX	POTENZA	CORR.NOM.(A)	IPMOTORE	RUMOROSITÀ	PESO	
MODEL	CODE	MOTOR	MARKING	N° POLES	REV. PER MIN.	VOLTAGE	FREQUENCY	FLOW RATE	MAX PRESS.	MAX PRESS.	POWER	NOM. CURR.	IP MOTOR	NOISE	WEIGHT	
EX-ATEX					(RPM)	(Volt)	(Hz)	(m³/h)	(Pa)	(Pa)	(W)	230V 400V		dB(A)	(kg)	
CS 310 4M	0032500	single p.	II2GExhT4	4	1400	230	50	500	16	157	200	1	-	IP55	64	10
CS 320 4M	0032700	single p.	II2GExhT4	4	1400	230	50	720	21	206	250	1,5	-	IP55	67	14
CS 310 4T	0032600	three p.	II2GExhT4	4	1400	230/400	50	500	16	157	200	1	0,59	IP55	64	13
CS 320 4T	0032800	three p.	II2GExhT4	4	1400	230/400	50	720	21	206	250	1,75	1,1	IP55	67	14
CS 330 4T	0032900	three p.	II2GExhT4	4	1400	230/400	50	1500	38	373	400	1,9	1,1	IP55	70	21
CS 340 4T	0032100	three p.	II2GExhT4	4	1400	230/400	50	1900	47	461	1000	3,5	2	IP55	73	31
CS 350 4T	0033000	three p.	II2GExhT4	4	1400	230/400	50	2900	50	490	1400	4	2,31	IP55	76	37
CS 360 4T	0032200	three p.	II2GExhT4	4	1400	230/400	50	4100	60	589	1900	5,7	3,3	IP55	80	44
CS 370 4T	0033100	three p.	II2GExhT4	4	1400	230/400	50	5600	73	716	2500	8,7	5	IP55	84	67
CS 380 4T	0033800	three p.	II2GExhT4	4	1400	230/400	50	9100	105	1030	4500	15,6	9	IP55	88	91

AMBITI APPLICATIVI

Indicato per installazione in ambito commerciale, terziario e industriale. Destinati all'utilizzo in atmosfera potenzialmente esplosiva:

- Negozi;
- Officine;
- Impianti sportivi;
- Supermercati e centri commerciali;
- Depositi e magazzini;
- Industrie;
- Macchinari.

ENVIRONMENTS APPLICATION

Suitable for Industrial, civil and commercial application where the risk of explosion is high.

- Shops;
- Workshops;
- Sports facilities;
- Supermarkets and shopping centers;
- Warehouse;
- Factories;
- Machinery

GRAFICI DI PORTATA - FLOW CHARTS

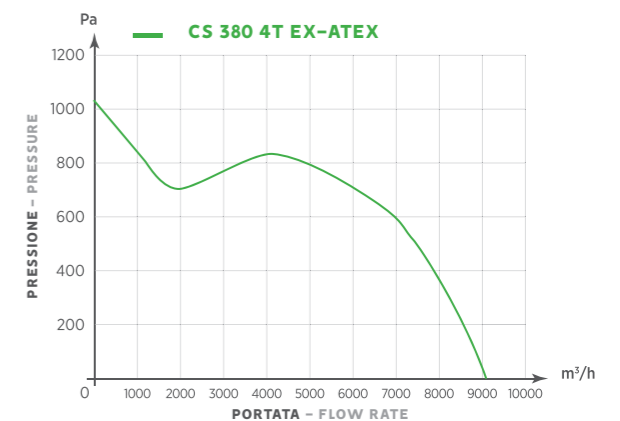
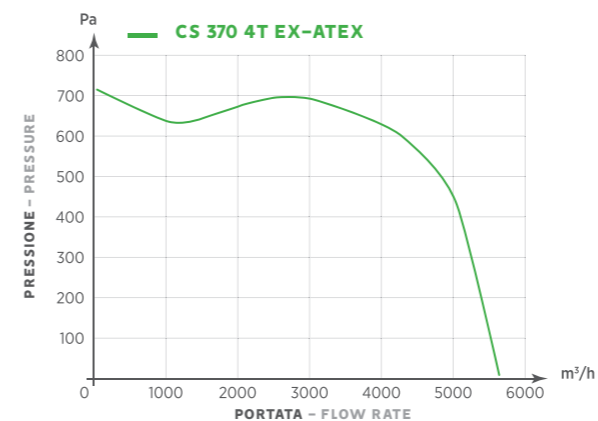
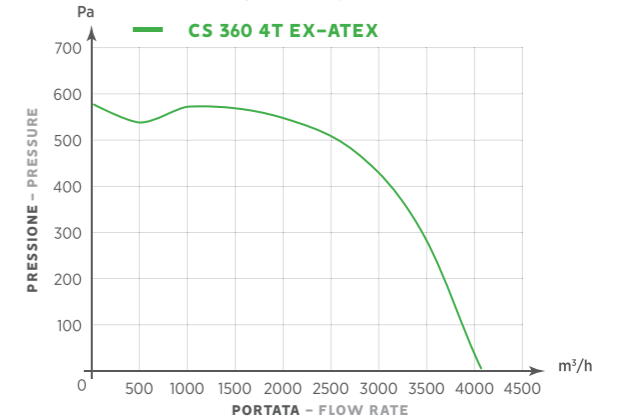
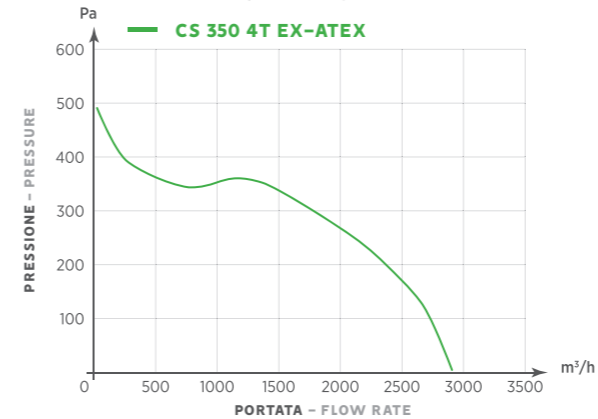
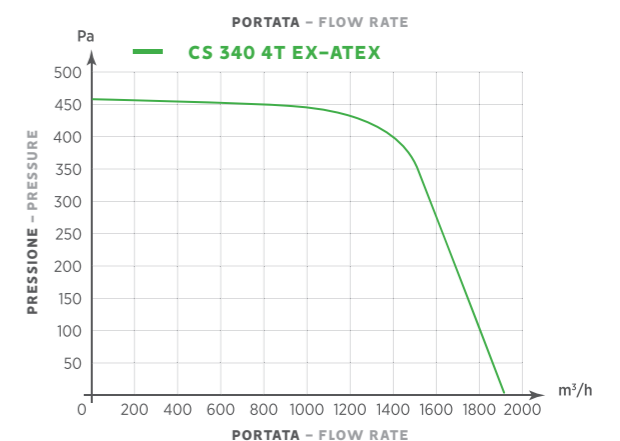
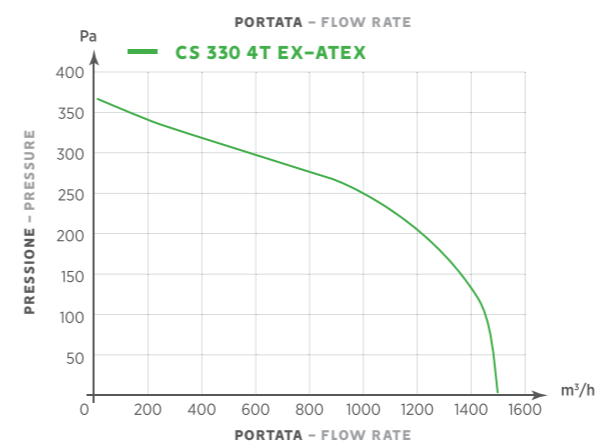
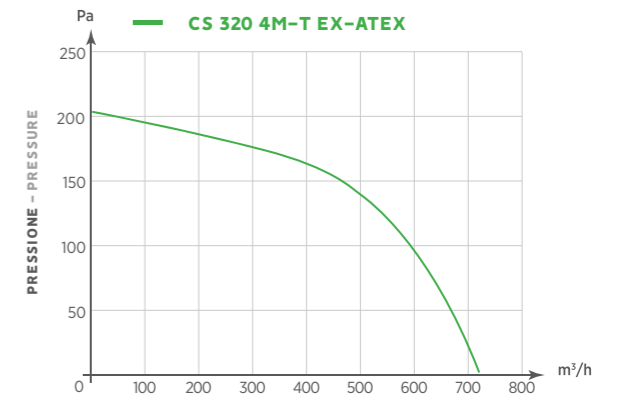
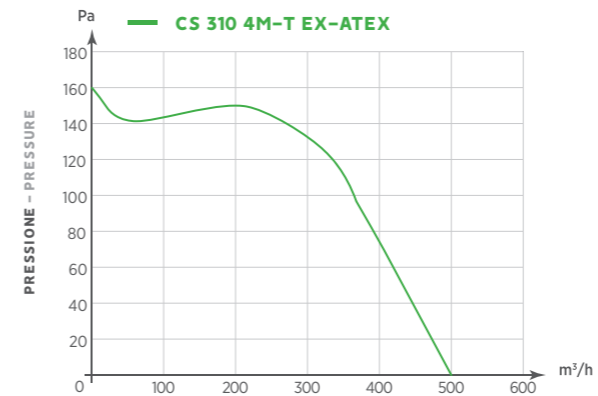

ACCESSORI INSTALLABILI FUORI ZONA EX ATEX (PAGINA 72) ACCESSORIES SUITABLE FOR INSTALLATION OUTSIDE OF THE EX ATEX AREA (PAGE 72)



Regulatori
Controllers

ANTIDEFAGRANTI EX-ATEX - EXPLOSION PROOF FANS EX-ATEX

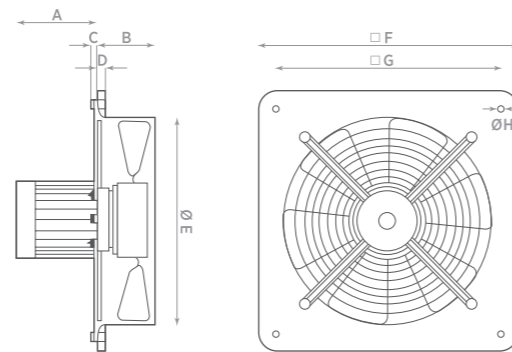

MODELLO MODEL	A	B	C	D	E	F	G	ØH
EB 25 4M/T EX-ATEX	190	66	9	8	260	340	325	8,3
EB 30 4M/T EX-ATEX	190	75	9	10	312	390	375	8,3
EB 35 4M/T EX-ATEX	190	85	10	12	365	460	439	12,3
EB 40 4M/T EX-ATEX	190	85	10	12	415	510	490	12,3
EB 50 4M/T EX-ATEX	190	101	10	15	515	630	610	12,3



Aspiratori assiali destinati all'utilizzo in atmosfera potenzialmente esplosiva (Direttiva ATEX 2014/34/UE nei paesi membri della Comunità Europea).

- Applicazioni a muro e pannello per convogliare l'aria direttamente all'esterno o in condotti brevi;
- Prodotti idonei per molte applicazioni in ambito industriale in presenza di gas, vapori e nebbie infiammabili;
- Aspiratore completo (e non solo parti elettriche) omologato con certificato CESI n° 03 ATEX 251;
- Aspiratore gruppo II, categoria 2 per gas, sicurezza costruttiva Ex h, livello protezione apparecchio (EPL) GB, max temp. sup. T4 (135°C);
- Utilizzabile in aree classificate come zona 1 e 2;
- Corpo in lamiera d'acciaio verniciato a forno con polveri epossidiche anticorrosione;
- Ventola in Nylon rinforzato conduttivo, autoestinguente di grado VO;
- Motore tipo Exd IIC T4 su cuscinetto a sfera classe F con grado di protezione IP55;
- Temperatura max aria aspirata: 40°C;
- Reversibilità: tutti i modelli;
- Appropriati test di sicurezza e prove specifiche hanno verificato come le soluzioni adottate soddisfino pienamente i requisiti essenziali della Direttiva;
- Normative di riferimento: EN 80079-36; EN 80079-37; EN 14986.
- **POSIZIONAMENTO:** a Muro

Explosion Proof Certified Axial fans to extract air and fumes directly outside through short ducting, wall or panel mounting, in compliance with ATEX Directive 2014/34/UE.

- Suitable for applications in commercial and industrial environments where the risk of explosion is high and where the surrounding atmosphere contains gas, vapours or highly inflammable steam;
- The whole product and not just the electrical parts, has been certified by CESI Institute with CESI n°3 ATEX 251 certificate;
- Fan group II, cat. 2 for gases, construction safety Ex h, device protection level (EPL) Gb, max surface temp. T4 (135°C) available on demand T5 and/or T6;
- Classified for zones 1 and 2;
- This approval has required specific safety tests and proper examinations on products to verify how the adopted solutions have satisfied the essential
- Directive requirements;
- Steel plated body protected by an epoxy-based anticorrosive paint;
- Impeller made of VO reinforced conductive nylon;
- Exd IIC T4, ball bearing class F insulation motor IP55 protected;
- Max temperature of extracted air: 40°C;
- Reversibility: all models;
- Reference Standards: EN 80079-36; EN 80079-37; EN 14986.
- **POSITIONING:** Wall mounting

DATI TECNICI - TECHNICAL DATA

MODELLO MODEL	CODICE CODE	MOTORE MOTOR	MARCATURA MARKING	N° POLI N° POLES	GIRI AL MINUTO REV. PER MIN.	TENSIONE VOLTAGE	FREQUENZA FREQUENCY	PORTATA FLOW RATE	PRESS. MAX. MAX PRESS.	PRESS. MAX. MAX PRESS.	POTENZA POWER	CORR. NOM. (A) NOM. CORR.	IP MOTORE IP MOTOR	RUMOROSITÀ NOISE	PESO WEIGHT	
EX-ATEX					(RPM)	(Volt)	(Hz)	(m³/h)	(mm H ₂ O)	(Pa)	(W)	230V 400V		dB(A) _{1m}	(kg)	
EB 25 4M	0035400	single p.	II 2G Ex h T4	4	1460	230	50	900	10	98	120	0,7	-	IP55	55	6,8
EB 30 4M	0035500	single p.	II 2G Ex h T4	4	1400	230	50	1500	12	118	140	0,75	-	IP55	59	7,2
EB 35 4M	0035600	single p.	II 2G Ex h T4	4	1350	230	50	2250	10	98	160	0,8	-	IP55	63	8,4
EB 40 4M	0035000	single p.	II 2G Ex h T4	4	1290	230	50	2900	9	88	180	0,85	-	IP55	66	9
EB 50 4M	0035100	single p.	II 2G Ex h T4	4	1200	230	50	4500	14	137	210	1	-	IP55	72	11,2
EB 25 4T	0035700	three p.	II 2G Ex h T4	4	1460	230/400	50	900	10	98	100	0,67	0,39	IP55	55	6,8
EB 30 4T	0035900	three p.	II 2G Ex h T4	4	1430	230/400	50	1500	12	118	125	0,69	0,40	IP55	59	7,2
EB 35 4T	0036000	three p.	II 2G Ex h T4	4	1400	230/400	50	2250	10	98	150	0,72	0,42	IP55	63	8,4
EB 40 4T	0036100	three p.	II 2G Ex h T4	4	1350	230/400	50	2900	9	88	180	0,74	0,43	IP55	66	9
EB 50 4T	0036200	three p.	II 2G Ex h T4	4	1270	230/400	50	4500	14	137	230	0,78	0,45	IP55	72	11,2

AMBITI APPLICATIVI

Indicato per installazione in ambito commerciale, terziario e industriale. Destinati all'utilizzo in atmosfera potenzialmente esplosiva:

- Negozi;
- Officine;
- Impianti sportivi;
- Supermercati e centri commerciali;
- Depositi e magazzini;
- Industrie;
- Macchinari.

ENVIRONMENTS APPLICATION

Suitable for industrial, civil and commercial application where the risk of explosion is high.

- Shops;
- Workshops;
- Sports facilities;
- Supermarkets and shopping centers;
- Warehouse;
- Factories;
- Machinery.

GRAFICI DI PORTATA - FLOW CHARTS

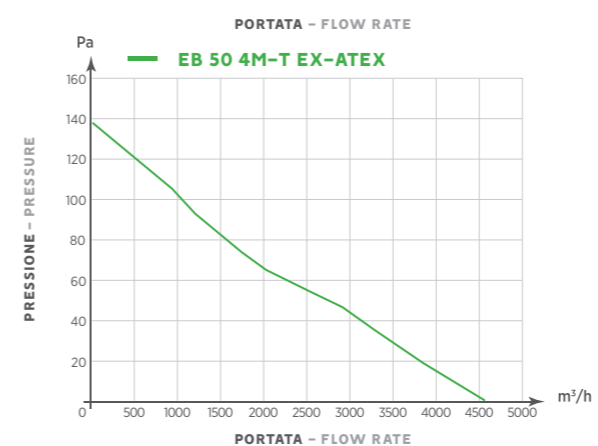
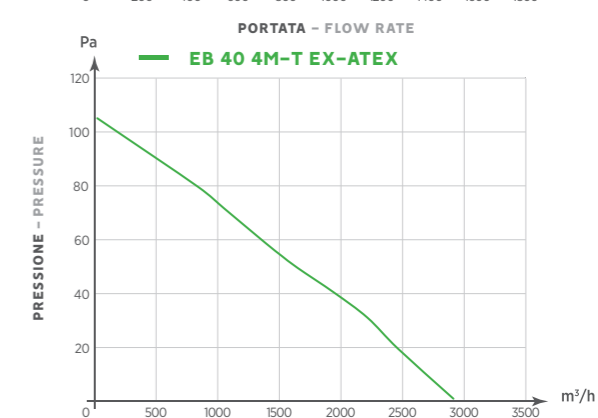
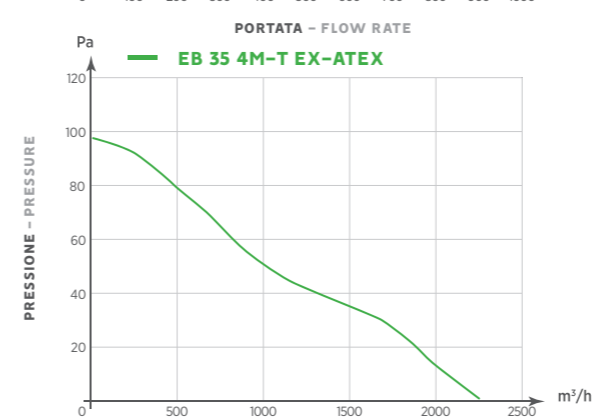
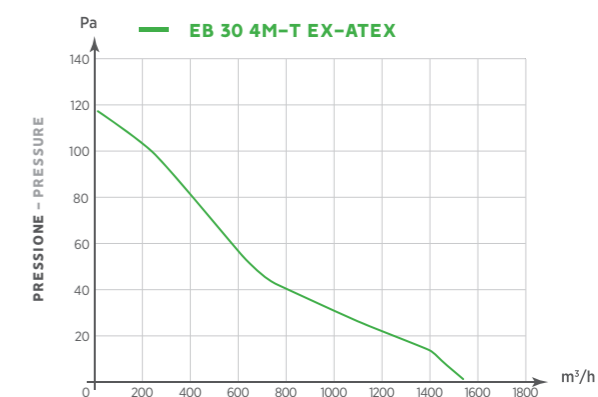
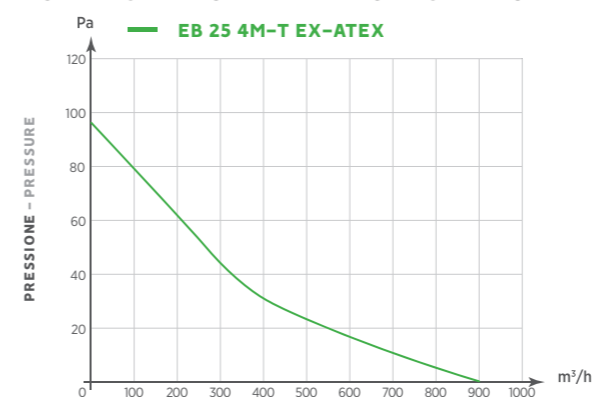

ACCESSORI (PAGINA 74) ACCESSORIES (PAGE 74)



Griglia di protezione
Protection grille



Serranda a gravità
Gravity shutter



Regolatori
Controllers

ACCESSORI INSTALLABILI FUORI ZONA EX ATEX (PAGINA 72) ACCESSORIES SUITABLE FOR INSTALLATION OUTSIDE OF THE EX ATEX AREA (PAGE 72)

CV-T HT 400° C 2H

VENTILATORI PER FUMI D'INCENDIO E AUTORIMESSE - SMOKE EXHAUST FANS FOR FIRE AND CAR GARAGES

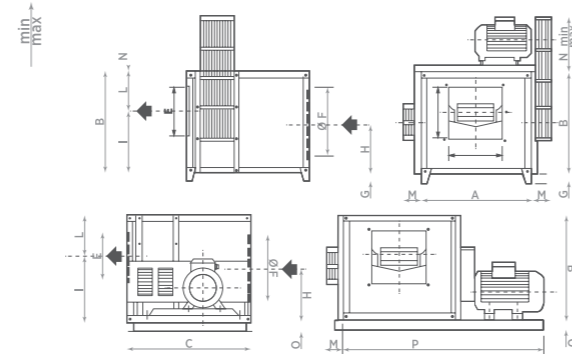

MODELLO	A	B	C	D	E	ØF	G	H	I	L	M	N	O	P
CV-T HT 250	600	600	650	300	300	405	100	300	370	230	158	270/350	-	-
CV-T HT 300	700	680	730	350	350	500	100	340	425	255	173	340/410	-	-
CV-T HT 350	800	750	860	400	400	610	100	375	470	280	173	340/410	80	1570
CV-T HT 400	900	840	1030	450	450	650	100	420	535	305	173	360/420	100	1670
CV-T HT 450	1000	960	1200	500	500	750	100	480	630	330	173	350/420	120	1750
CV-T HT 500	1200	1020	1250	600	600	800	100	510	640	380	173	380/420	120	2150



■ Serie di ventilatori cassonati centrifughi a doppia aspirazione a trasmissione progettati per utilizzo in impianti di aspirazione fumi industriali o per evacuazione fumi in caso d'incendio secondo la classificazione F400.

- Temperatura max aria aspirata: 200°C in servizio continuo, 400°C per 2 ore in caso di incendio;
- Gamma composta da 6 taglie, con portate d'aria da 1500 a 35000 m³/h e pressioni statiche da 10 a 180 mm H₂O;
- Girante a pale avanti, doppia aspirazione;
- Cassone in lamiera zincata;
- I motori sono della serie UNEL MEC IP 55 classe F a singola o doppia velocità su richiesta;
- Omologato F400 da Ente Qualificato Autonomo;
- Conforme alla norma UNI-EN 12101-3.
- **POSIZIONAMENTO:** a Pavimento

■ Box belt driven centrifugal fans with double inlet designed to be used in fume extraction system or evacuation in case of fire according to the F400 classification.

- Suitable for continuous service at 200°C air temperature and, in case of fire (emergency) at 400°C for 2 hours;
- Series composed by 6 sizes with flow rate starting from 1.500 up to 35.000 m³/h and pressure starting from 10 up to 180 mm H₂O;
- Forward curved blades, double inlet;
- Case in galvanised sheet;
- UNEL-MEC motor IP55 protected, Class F, single speed or double speed on request;
- In compliance with Standard UNI-EN 12101-3;
- F400 approved by an Acknowledged Qualified Institute
- **POSITIONING:** Floor mounting

DATI TECNICI - TECHNICAL DATA

MODELLO	CODICE	MOTORE	N° POLI	GIRI AL MINUTO	TENSIONE	FREQUENZA	PORTATA	PRESS. MAX	PRESS. MAX	POTENZA	CORR. NOM. (A)	IP MOTORE	RUMOROSITÀ	PESO
MODEL	CODE	MOTOR	N° POLES	REV. PER MIN.	VOLTAGE	FREQUENCY	FLOW RATE	MAX PRESS.	MAX PRESS.	POWER	NOM. CORR.	IP MOTOR	NOISE	WEIGHT
				(RPM)	(Volt)	(Hz)	(m³/h)	(mm H ₂ O)	(mm H ₂ O)	(W)	230V 400V		dB(A) _{1m}	(Kg)
CV-T HT 250-2,2	0012601	three p.	4	1800	400	50	5700	75	736	2,20	8,1 4,7	IP55	70	85
CV-T HT 250-1,5	0012603	three p.	4	1600	400	50	5100	60	589	1,50	5,6 3,2	IP55	68	75
CV-T HT 250-1,1	0012605	three p.	4	1400	400	50	4400	45	441	1,10	4,2 2,4	IP55	65	75
CV-T HT 250-0,75	0012607	three p.	4	1200	400	50	3700	32	314	0,75	3,1 1,8	IP55	61	70
CV-T HT 250-0,37	0012609	three p.	4	1000	400	50	3100	23	226	0,37	1,8 1,1	IP55	57	68
CV-T HT 300-5,5	0012611	three p.	4	1800	400	50	9700	110	1079	5,50	18,9 10,9	IP55	76	130
CV-T HT 300-4	0012613	three p.	4	1600	400	50	8800	88	863	4,00	13,6 7,9	IP55	73	120
CV-T HT 300-3	0012615	three p.	4	1400	400	50	7700	66	647	3,00	11,0 6,4	IP55	71	110
CV-T HT 300-2,2	0012617	three p.	4	1200	400	50	6700	47	461	2,20	8,1 4,7	IP55	67	110
CV-T HT 300-1,1	0012619	three p.	4	1000	400	50	5600	33	324	1,10	4,2 2,4	IP55	63	100
CV-T HT 350-11	0012621	three p.	4	1600	400	50	13300	112	1099	11,00	36,0 20,8	IP55	78	250
CV-T HT 350-5,5	0012623	three p.	4	1400	400	50	12000	85	834	5,50	18,9 10,9	IP55	75	180
CV-T HT 350-4	0012625	three p.	4	1200	400	50	10500	63	618	4,00	13,6 7,9	IP55	72	170
CV-T HT 350-2,2	0012627	three p.	4	1000	400	50	8500	44	432	2,20	8,1 4,7	IP55	68	160
CV-T HT 350-1,1	0012629	three p.	4	800	400	50	6400	27	265	1,10	4,2 2,4	IP55	63	150
CV-T HT 400-11	0012631	three p.	4	1400	400	50	18200	118	1158	11,00	36,0 20,8	IP55	78	310
CV-T HT 400-7,5	0012633	three p.	4	1200	400	50	16000	83	814	7,50	25,4 14,7	IP55	76	300
CV-T HT 400-4	0012635	three p.	4	1000	400	50	13000	58	569	4,00	13,6 7,9	IP55	72	220
CV-T HT 400-2,2	0012637	three p.	4	800	400	50	10200	37	363	2,20	8,1 4,7	IP55	67	210
CV-T HT 450-22	0012639	three p.	4	1400	400	50	25500	150	1472	22,00	69,7 40,3	IP55	78	520
CV-T HT 450-15	0012641	three p.	4	1200	400	50	22000	112	1099	15,00	48,1 27,8	IP55	76	440
CV-T HT 450-7,5	0012643	three p.	4	1000	400	50	18000	78	765	7,50	25,4 14,7	IP55	72	360
CV-T HT 450-4	0012645	three p.	4	800	400	50	14800	50	491	4,00	13,6 7,9	IP55	67	270
CV-T HT 450-1,5	0012647	three p.	4	600	400	50	11100	28	275	1,50	5,6 3,2	IP55	64	250
CV-T HT 500-30	0012649	three p.	4	1400	400	50	35000	180	1766	30,00	94,5 54,6	IP55	86	610
CV-T HT 500-22	0012651	three p.	4	1200	400	50	30000	135	1324	22,00	69,7 40,3	IP55	82	580
CV-T HT 500-15	0012653	three p.	4	1000	400	50	25000	90	883	15,00	48,1 27,8	IP55	78	500
CV-T HT 500-7,5	0012655	three p.	4	800	400	50	20000	60	589	7,50	25,4 14,7	IP55	74	420
CV-T HT 500-3	0012657	three p.	4	600	400	50	15100	32	314	3,00	11,0 6,4	IP55	68	310

AMBITI APPLICATIVI

- Indicato per
- Estrazione fumi da impianti industriali;
- Impianti di estrazione fumi in caso d'incendio nel settore residenziale, commerciale e terziario

ENVIRONMENTS APPLICATION

- Suitable for:
- Fume extraction from industrial plants;
- Smoke extraction systems in case of fire in residential, commercial and/or tertiary environment

GRAFICI DI PORTATA - FLOW CHARTS

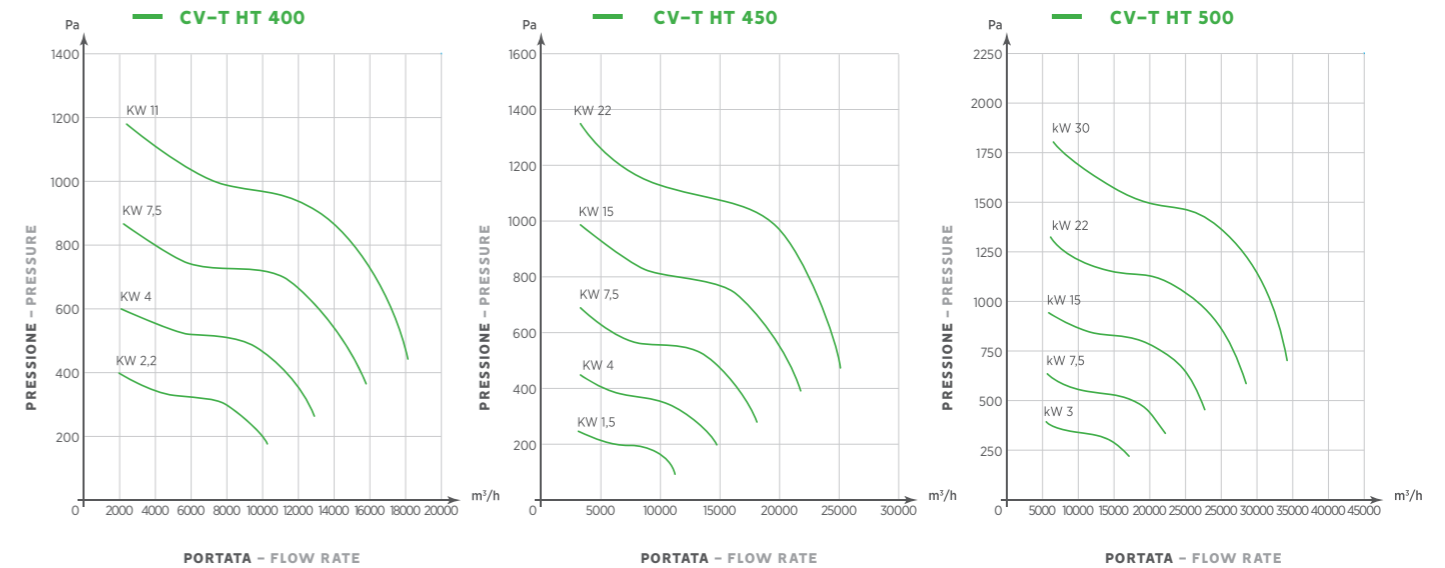
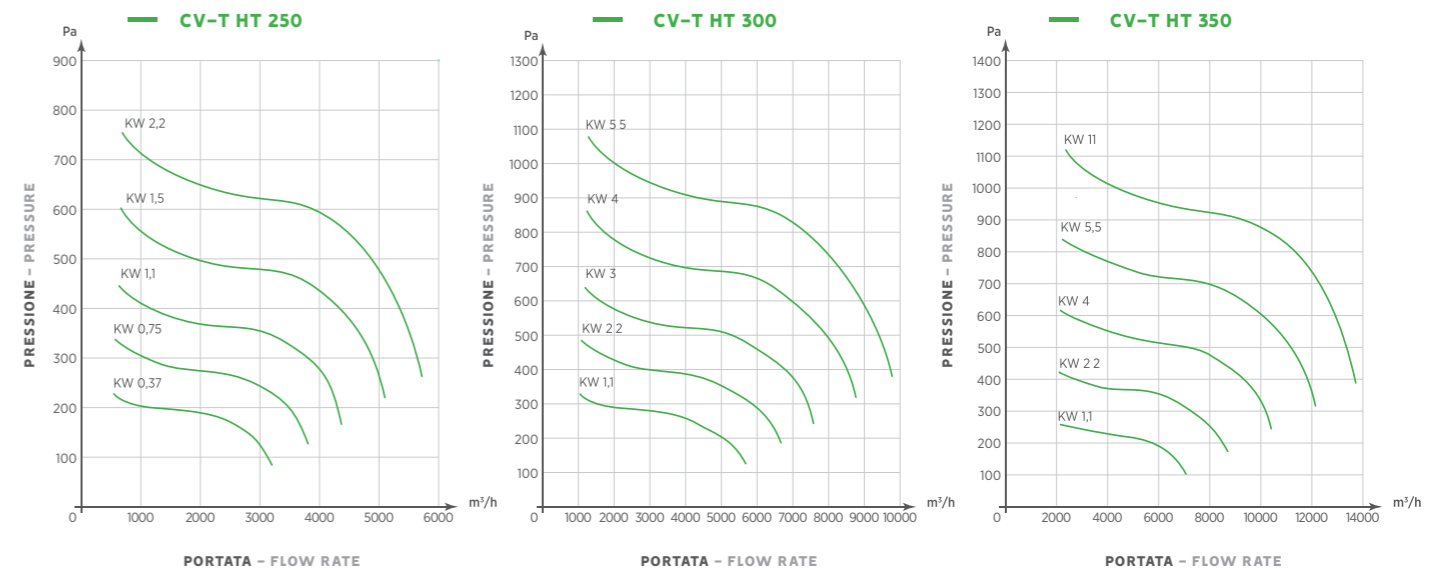

ACCESSORI DISPONIBILI A RICHIESTA
ACCESSORIES AVAILABLE ON DEMAND

TXP 400°C 2h

VENTILATORE PER FUMI D'INCENDIO E AUTORIMESSE - SMOKE EXHAUST FANS FOR FIRE AND CAR GARAGES

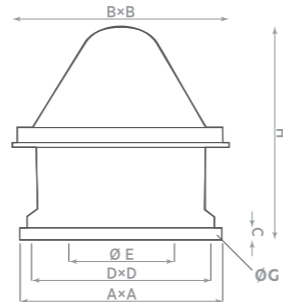

MODELLO MODEL	A x A	B x B	C	D x D	Ø E	Ø G	H
TXP 6	400	470	40	350	250	11,2	520
TXP 7	560	595	40	460	300	11,2	650
TXP 8	560	595	40	460	350	11,2	650
TXP 10	710	800	40	610	400	11,2	700
TXP 12	900	1000	40	800	500	11,2	880
TXP 14	900	1000	45	800	550	11,2	910
TXP 15	900	1000	45	800	600	11,2	940
TXP 18	900	1000	45	800	600	11,2	960



- Garantisce l'evacuazione dei fumi in caso di incendio.
- Indicato per installazione dove sia richiesta l'estrazione di aria o esalazioni in caso di incendio.
- Estrae aria o esalazioni provenienti da condotti o direttamente dall'ambiente;
- Portate d'aria medio-alte con pressioni in grado di superare perdite di carico anche notevoli, dovute alle resistenze dei condotti;
- Indicato per installazione dove sia richiesta l'estrazione di aria o esalazioni in caso di incendio, ad esempio per industrie, impianti sportivi, supermercati e centri commerciali, cinema, uffici;
- Prodotto di lunga durata grazie all'utilizzo di un motore ad induzione con cuscinetti a sfera, grado di protezione motore IP55, isolamento in classe F e ventola per autoraffreddamento;
- Temperatura max aria aspirata in continuo: 60°C;
- Temperatura max di aria e fumi aspirati in caso di incendio: 400°C (max 2 ore);
- Estrema facilità d'installazione;
- Corpo in lamiera di acciaio zincato, cappello di protezione in ABS;
- Griglia di protezione anti-infortunistica;
- Ventola centrifuga autopulente a pale rovesce;
- Omologazione secondo la NORMA EN 12101-3.
- POSIZIONAMENTO:** a Tetto

- Centrifugal roof fans to extract air 400°C 2h with horizontal outlet. Centrifugal roof fans to extract air or fumes directly outside or through ducts;
- Medium-high flow rates to overcome pressure losses due to duct resistance;
- Suitable to be installed where is required to extract air or fumes in case of fire such as: industries, sports facilities, supermarket and shopping centres, cinemas, offices;
- Ball bearing class F insulation motor IP55 protected;
- Max temperature of extracted air in continuous operation: 60°C;
- Max temperature of extracted air in case of fire: 400°C for 2 hours;
- Easy installation;
- Zinc plated steel frame, protection cover in ABS material;
- Safety protection outside grille;
- Self cleaning backward centrifugal impeller;
- In accordance with European Standard: EN 12101-3.
- POSITIONING:** Roof mounting

DATI TECNICI - TECHNICAL DATA

MODELLO MODEL	CODICE CODE	MOTORE MOTOR	N° POLI N° POLES	GIRI AL MINUTO REV. PER MIN.	TENSIONE VOLTAGE	FREQUENZA FREQUENCY	PORTATA FLOW RATE	PRESS. MAX MAX PRESS.	PRESS. MAX MAX PRESS.	POTENZA POWER	CORR. NOM. (A) NOM. CURR.	IP MOTORE IP MOTOR	RUMOROSITÀ NOISE	PESO WEIGHT	
				(RPM)	(Volt)	(Hz)	(m³/h)	(mm H₂O)	(Pa)	(W)	230V 400V		dB(A) _{1m}	(kg)	
TXP 6M 4P 400 2H	0074240	single p.	4	1400	230	50	1800	30	294	180	1,05	-	IP55	66	20
TXP 7M 4P 400 2H	0074340	single p.	4	1400	230	50	3100	40	392	250	1,4	-	IP55	69	28
TXP 8M 4P 400 2H	0074440	single p.	4	1400	230	50	4200	45	441	370	1,9	-	IP55	70	34
TXP 10M 4P 400 2H	0074540	single p.	4	1400	230	50	5700	56	549	750	3,4	-	IP55	75	45
TXP 6T 4P 400 2H	0074740	three p.	4	1400	230/400	50	1800	30	294	180	1,05	0,6	IP55	66	20
TXP 7T 4P 400 2H	0074840	three p.	4	1400	230/400	50	3100	40	392	250	1,42	0,82	IP55	69	28
TXP 8T 4P 400 2H	0074940	three p.	4	1400	230/400	50	4200	45	441	370	1,9	1,1	IP55	70	34
TXP 10T 4P 400 2H	0075040	three p.	4	1400	230/400	50	5700	56	549	750	3,4	1,8	IP55	75	45
TXP 12T 6P 400 2H	0075140	three p.	6	900	230/400	50	7100	39	382	750	3,81	2,2	IP55	71	63
TXP 14T 6P 400 2H	0075240	three p.	6	900	230/400	50	10800	48	471	1100	5,37	3,1	IP55	75	85
TXP 15T 6P 400 2H	0075440	three p.	6	900	230/400	50	14200	57	559	2200	9,35	5,4	IP55	80	105
TXP 18T 6P 400 2H	0075540	three p.	6	900	230/400	50	18800	65	637	3000	11,95	6,9	IP55	84	120

AMBITI APPLICATIVI

- Adatti per impianti di evacuazione fumi in caso d'incendio in:
- Centri commerciali;
- Parcheggi interrati;
- Ospedali;
- Scuole;
- Teatri;
- Musei;
- Palazzi e grattacieli.

ENVIRONMENTS APPLICATION

- Suitable for evacuation systems in case of fire in:
- Shopping centers;
- Underground car parkings;
- Hospitals;
- Schools;
- Theatres;
- Museums;
- Buildings and skyscrapers



GRAFICI DI PORTATA - FLOW CHARTS

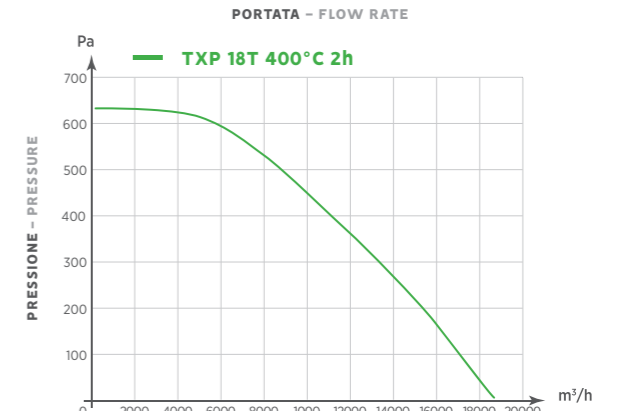
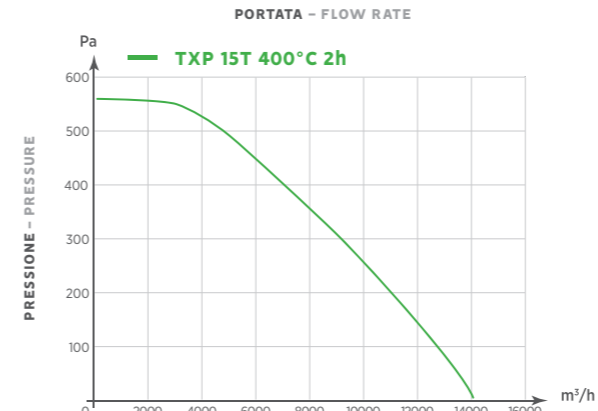
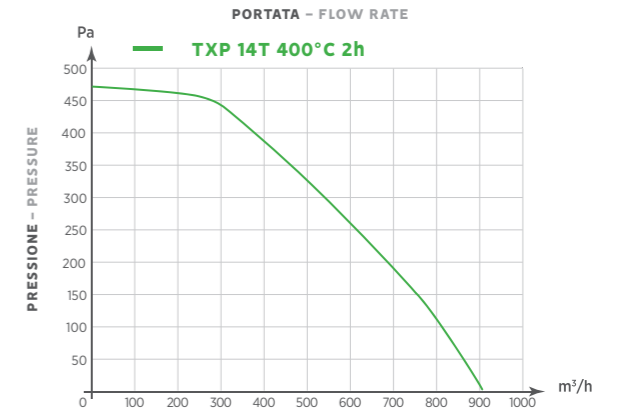
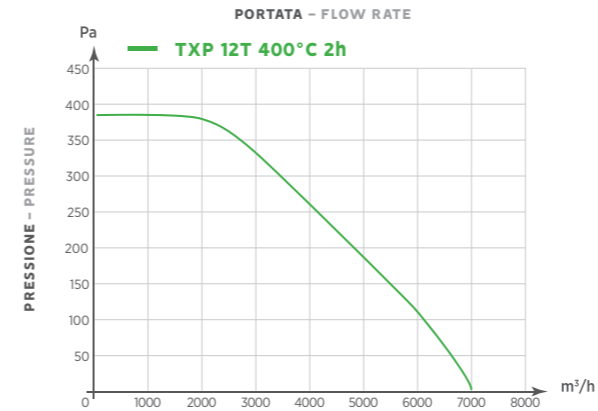
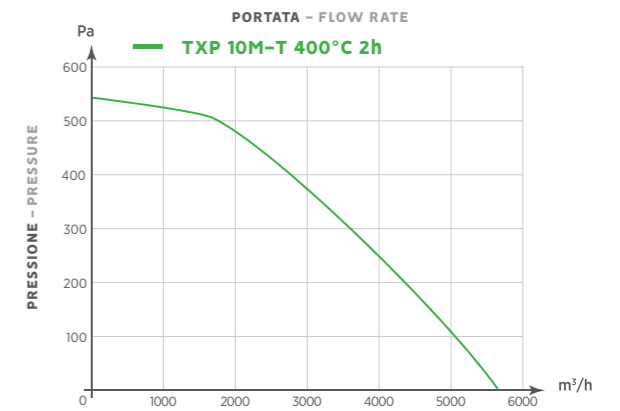
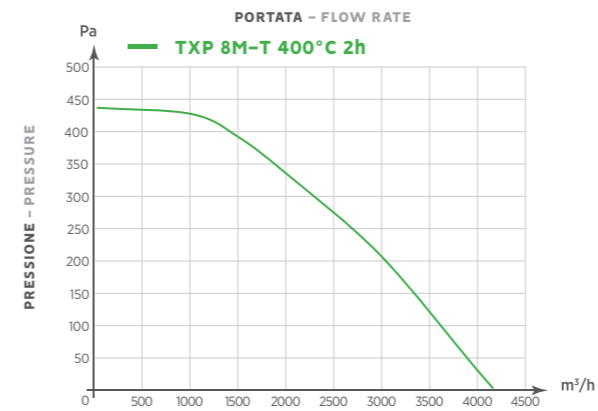
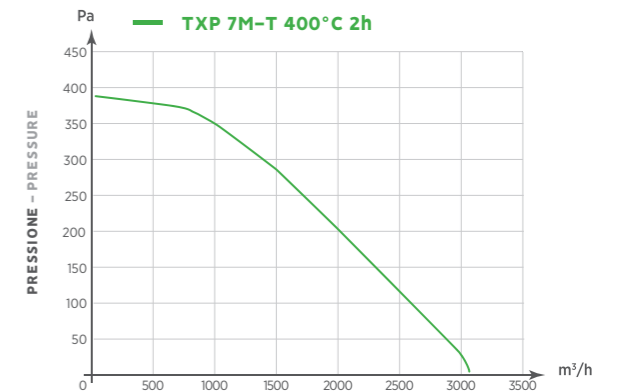
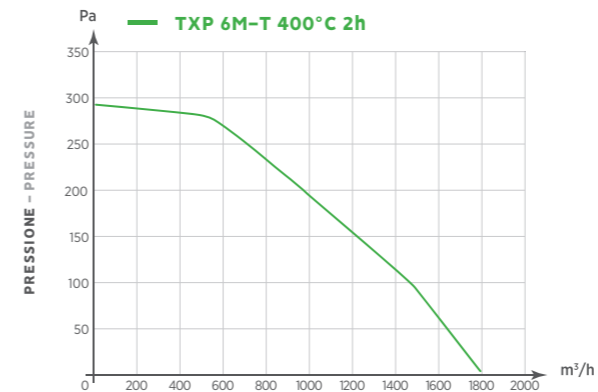

ACCESSORI (PAGINA 72, 74) - ACCESSORIES (PAGE 72, 74)



Controtelaio di base
Frame base

TXV 400°C 2h

VENTILATORE PER FUMI D'INCENDIO E AUTORIMESSE - SMOKE EXHAUST FANS FOR FIRE AND CAR GARAGES

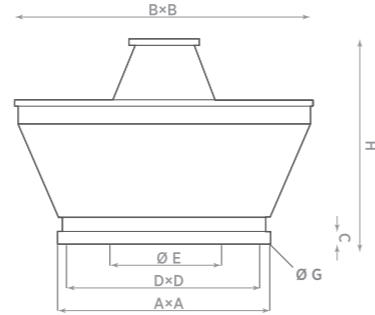

MODELLO MODEL	AxA	BxB	C	DxD	ØE	ØG	H
TXV 6	400	595	40	350	250	11,2	500
TXV 7	560	800	40	460	300	11,2	640
TXV 8	560	800	40	460	350	11,2	640
TXV 10	710	1000	40	610	400	11,2	700
TXV 12	900	1260	40	800	500	11,2	780
TXV 14	900	1260	45	800	550	11,2	820
TXV 15	900	1260	45	800	600	11,2	870



Torrini a scarico verticale idonei per il funzionamento d'emergenza; garantiscono l'evacuazione dei fumi in caso di incendio.

- Estrae aria o esalazioni provenienti da condotti o direttamente dall'ambiente;
- Portate d'aria medio-alte con pressioni in grado di superare perdite di carico anche notevoli, dovute alle resistenze dei condotti;
- Indicato per installazione dove sia richiesta l'estrazione di aria o esalazioni in caso di incendio, ad esempio per industrie, impianti sportivi, supermercati e centri commerciali, cinema, uffici;
- Prodotto di lunga durata grazie all'utilizzo di un motore ad induzione con cuscinetti a sfera, grado di protezione motore IP55, isolamento in classe F e ventola per autoraffreddamento;
- Temperatura max aria aspirata in continuo: 60°C;
- Temperatura max di aria e fumi aspirati in caso di incendio: 400°C (max 2 ore);
- Estrema facilità d'installazione;
- Corpo in lamiera di acciaio zincato, convogliatore d'aria in ABS;
- Griglia di protezione anti-infortunistica;
- Ventola centrifuga autopulente a pale rovesce;
- Omologazione secondo la NORMA EN 12101-3.
- POSIZIONAMENTO:** a Tetto

Centrifugal roof fans to extract air 400°C 2h with vertical outlet.

Centrifugal roof fans to extract air or fumes directly outside or through ducts;

- The vertical extracted air avoids to stain the lateral walls or components;
- Medium-high flow rates to overcome pressure losses due to duct resistance;
- Suitable to be installed where is required to extract air or fumes in case of fire such: industries, sports facilities, supermarket and shopping centres, cinemas, offices;
- Ball bearing class F insulation motor IP55 protected;
- Max temperature of extracted air in continuous operation: 60°C;
- Max temperature of extracted air in case of fire: 400°C for 2 hours;
- Easy installation;
- Zinc plated steel frame, protection cover in ABS material;
- Safety protection outside grille;
- Self cleaning backward centrifugal impeller;
- In accordance with European Standard: EN 12101-3.
- POSITIONING:** Roof mounting

DATI TECNICI - TECHNICAL DATA

MODELLO MODEL	CODICE CODE	MOTORE MOTOR	N° POLI N° POLES	GIRI AL MINUTO REV. PER MIN. (RPM)	TENSIONE VOLTAGE (Volt)	FREQUENZA FREQUENCY (Hz)	PORTATA FLOW RATE (m³/h)	PRESS. MAX MAX PRESS. (mm H₂O)	PRESS. MAX MAX PRESS. (Pa)	POTENZA POWER (W)	CORR. NOM. (A) NOM. CURR. 230V 400V	IP MOTORE IP MOTOR	RUMOROSITÀ NOISE dB(A) _{1m}	PESO WEIGHT (Kg)
TXV 6M 4P 400 2H	0074260	single p.	4	1400	230	50	1800	30	294	180	1,05 -	IP55	66	25
TXV 7M 4P 400 2H	0074360	single p.	4	1400	230	50	3100	40	392	250	1,4 -	IP55	69	33
TXV 8M 4P 400 2H	0074460	single p.	4	1400	230	50	4200	45	441	370	1,9 -	IP55	70	40
TXV 10M 4P 400 2H	0074560	single p.	4	1400	230	50	5700	56	549	750	3,4 -	IP55	75	52
TXV 6T 4P 400 2H	0074760	three p.	4	1400	230/400	50	1800	30	294	180	1,05 0,6	IP55	66	25
TXV 7T 4P 400 2H	0074860	three p.	4	1400	230/400	50	3100	40	392	250	1,42 0,82	IP55	69	33
TXV 8T 4P 400 2H	0074960	three p.	4	1400	230/400	50	4200	45	441	370	1,9 1,1	IP55	70	40
TXV 10T 4P 400 2H	0075060	three p.	4	1400	230/400	50	5700	56	549	750	3,4 1,8	IP55	75	52
TXV 12T 6P 400 2H	0075160	three p.	6	900	230/400	50	7100	39	382	750	3,81 2,2	IP55	71	73
TXV 14T 6P 400 2H	0075260	three p.	6	900	230/400	50	10800	48	471	1100	5,37 3,1	IP55	75	95
TXV 15T 6P 400 2H	0075460	three p.	6	900	230/400	50	14200	57	559	2200	9,35 5,4	IP55	80	116
TXV 18T 6P 400 2H	0075560	three p.	6	900	230/400	50	18800	65	637	3000	11,95 6,9	IP55	84	132

AMBITI APPLICATIVI

- Adatti per impianti di evacuazione fumi in caso d'incendio in:
- Centri commerciali;
 - Parcheggi interrati;
 - Ospedali;
 - Scuole;
 - Teatri;
 - Musei;
 - Palazzi e grattacieli.

ENVIRONMENTS APPLICATION

- Suitable for evacuation systems in case of fire in:
- Shopping centers;
 - Underground car parkings;
 - Hospitals;
 - Schools;
 - Theatres;
 - Museums;
 - Buildings and skyscrapers

GRAFICI DI PORTATA - FLOW CHARTS

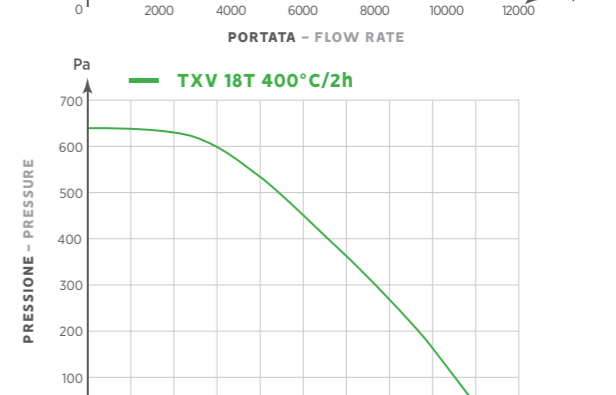
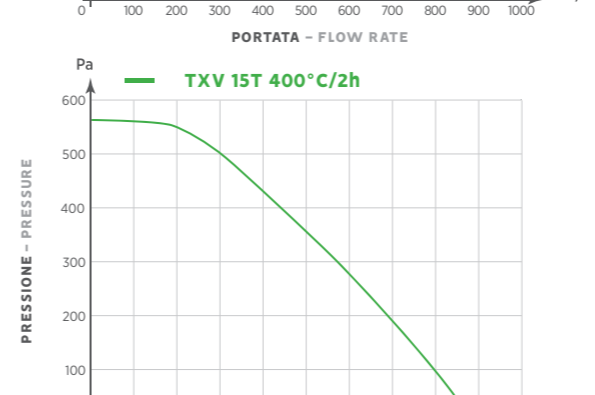
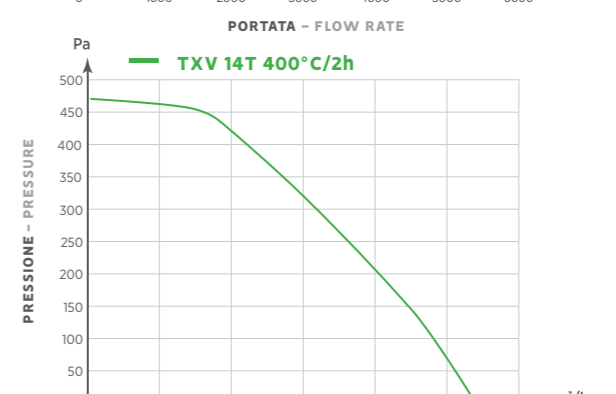
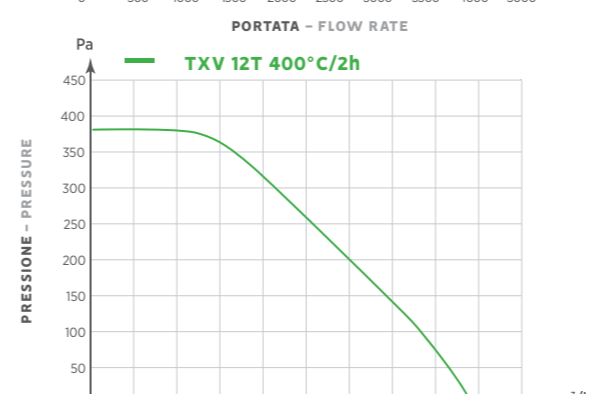
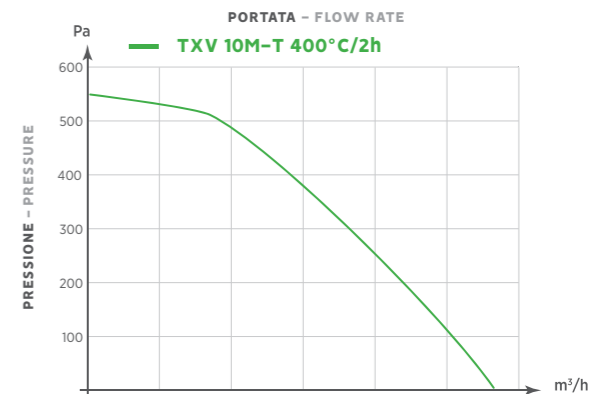
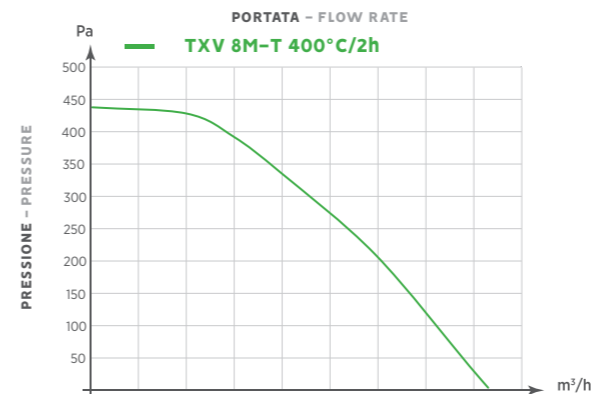
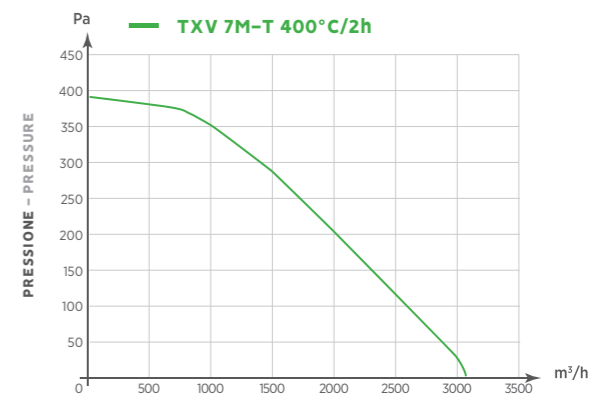
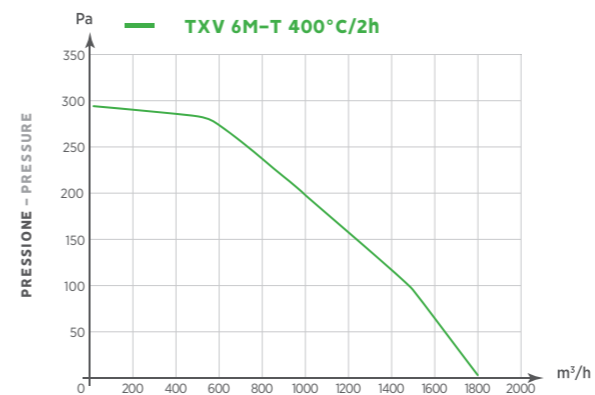

ACCESSORI (PAGINA 72, 74) - ACCESSORIES (PAGE 72, 74)



Controtelaio di base
Frame base

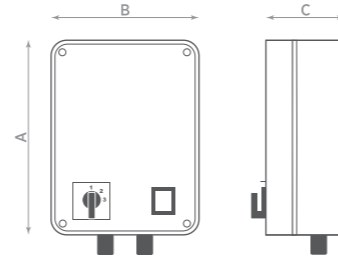

DESCRIZIONE DESCRIPTION	CODICE CODE	I MAX	POTENZA POWER	A	B	C
RGM 2	0030000	1,6 A	350 VA	108	108	100
RGM 10 (0-10V)	0030600	-	-	108	108	100
RGM 4	0030200	4 A	900 VA	250	190	140
RGT 1	0030300	1 A	700 VA	250	190	140
RGT 2	0030400	2 A	1300 VA	320	240	150
RG 10	0031300	-	-	105	125	52

CE IP55 □ (RGM2 - RGM10)

- Regolatori di velocità per ventilatori industriali;
- Corpo in materiale plastico;
- Spia di funzionamento;
- Grado di protezione: IP55;
- Dotati di passacavo;
- Predisposti per l'installazione a muro.

- Speed controllers for industrial fans;
- Body made of plastic material;
- Equipped with an operating indication light;
- IP55 protected;
- Equipped with cable gland;
- Suitable for wall installation.

SERIE SERIES	MODELLO MODEL	RGM 2	RGM 4	RGT 1	RGT 2	RGM 10
TURBO – TURBOPLAST	Tutti i modelli – All models	•				
AC	150 2M	•				
	150 2T			•		
CB	210 2M – 220 2M	•				
	230 2M – 240 2M		•			
	210 2T – 220 2T			•		
	230 2T – 240 2T				•	
CS	310 4M	•				
	320 4M		•			
	310 4T			•		
	320 4T – 330 4T – 340 4T				•	
CAI	510 2M – 520 2M	•				
	530 2M – 540 2M		•			
	510 2T – 520 2T			•		
	530 2T – 540 2T				•	
CAA	610 2T – 620 4T			•		
	630 4T				•	
TXC	Tutti i modelli – All models	•				
TURBOCAMINO		•				
TXP – TXV	3M – 6M	•				
	7M – 8M – 10M		•			
	3T – 6T – 7T			•		
	8T – 10T				•	
AXIA DES	450 6M	•				
	600 6M – 710 6M		•			
AXIA AI	25 2M – 25 4M – 30 4M – 35 4M – 40 4M	•				
	30 2M – 45 4M		•			
	25 2T – 30 2T – 25 4T – 30 4T – 35 4T – 40 4T			•		
	45 4T – 50 4T – 60 6T				•	
AXIA AI ECO	25M – 30M – 35M – 40M – 45M – 50M – 60M					•
AXIA LD	20 4M – 25 4M – 30 4M – 35 4M	•				
AXIA MD	25 4M – 30 4M – 35 4M – 40 4M – 50 6M – 60 6M	•				
	50 4M – 60 4M		•			
	25 4T – 30 4T – 35 4T – 40 4T – 50 6T – 60 6T – 60 4T – 60 6T			•		
AXIA HD	25 4M – 30 4M – 35 4M – 40 4M – 50 6M	•				
	50 4M – 60 4M – 60 6M		•			
	25 4T – 30 4T – 35 4T – 40 4T – 50 6T			•		
	50 4T – 60 4T – 60 6T				•	
AXIA TT	20 2M – 20 4M – 25 4M – 30 4M – 35 4M – 40 4M	•				
	25 4T – 30 4T – 35 4T – 40 4T			•		
	50 4T – 60 6T					•
AXIA TT ECO	25 M – 30 M – 35 M – 40 M – 50 M – 60 M					•

REGOLATORI – CONTROLLERS

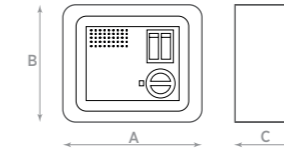

Controllano l'accensione e lo spegnimento del prodotto e ne regolano la velocità di funzionamento. Incassabili nel muro tramite apposito accessorio. RGE: regolazione continua della velocità dei prodotti monofase con potenza massima fino a 300 W. Inversione del flusso d'aria sui prodotti reversibili. RG10: Regolatore elettronico per la regolazione continua della velocità dei prodotti equipaggiati con motore a commutazione elettronica con regolazione 0-10 Volt.

RGE: Electronic controller with stepless speed. To control motor ON/OFF; variable speed and airflow reversibility (if available on the product). RG 10: Electronic controller to regulate the speed of products equipped with EC motors 0-10V voltage at speed controlled. They can be recessed through a dedicated accessory Code 0090500 (on request).

MODELLO MODEL	CODICE CODE	ADATTO PER SERIE SUITABLE FOR SERIES	A	B	C
RGE	0031700	Aspiratori monofasici fino a 300 W Single phase fans up to 300 W	125	105	52
RG 10 (0-10 V)	0031300	AXIA TT ECO – AXIA AI ECO	125	105	52
SCATOLA INCASSO REGOLATORE RECESSED WALL KIT CONTROLLER RG 10 (0-10 V)	0090500	RGE – RG 10	125	105	52

GRIGLIA DI PROTEZIONE – PROTECTION GRILLE

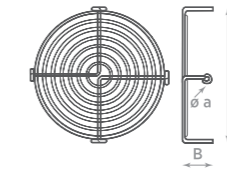
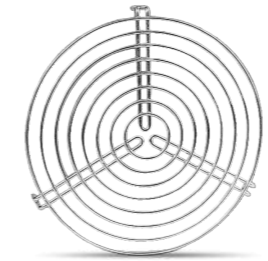

DESCRIZIONE DESCRIPTION	CODICE CODE	ADATTO PER SUITABLE FOR	ØA	B	ØB
GRIGLIA DI PROTEZIONE 100 PROTECTION GRILLE	0060800	Turbo 100	100	20	4,5
GRIGLIA DI PROTEZIONE 125 PROTECTION GRILLE	0060900	Turbo 125	125	20	4,5
GRIGLIA DI PROTEZIONE 150 PROTECTION GRILLE	0061000	AC – Turbo 150	150	20	4,5
GRIGLIA DI PROTEZIONE 160 PROTECTION GRILLE	0062900	Turbo 160	160	20	4,5
GRIGLIA DI PROTEZIONE 200 PROTECTION GRILLE	0061100	Turbo 200	200	20	4,5
GRIGLIA DI PROTEZIONE 250 PROTECTION GRILLE	0061200	Turbo 250	250	20	4,5
GRIGLIA DI PROTEZIONE 315 PROTECTION GRILLE	0061300	Turbo 315	315	20	4,5

FASCETTA STRINGITUBO – DUCT CLAMP

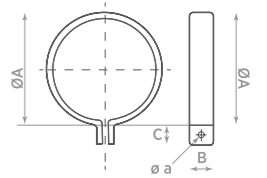

DESCRIZIONE DESCRIPTION	CODICE CODE	ADATTO PER SUITABLE FOR	ØA	B	C	ØB
FASCETTA STRINGITUBO 100 DUCT CLAMP	0061400	Turbo Turboplast 100	105	40	20	7
F. STRINGITUBO 125 DUCT CLAMP	0061500	Turbo Turboplast 125	130	40	20	7
F. STRINGITUBO 150/160 DUCT CLAMP	0062000	AC – Turbo Turboplast150/160	165	40	20	7
F. STRINGITUBO 200 DUCT CLAMP	0061700	Turbo 200	205	40	20	7
F. STRINGITUBO 250 DUCT CLAMP	0061800	Turbo 250	255	40	20	7
F. STRINGITUBO 315 DUCT CLAMP	0061900	Turbo 315	320	40	20	7

SERRANDA ANTIRITORNO – BACKDRAUGHT SHUTTER

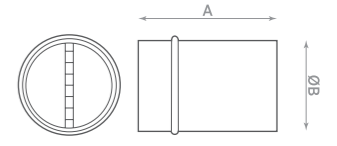

DESCRIZIONE DESCRIPTION	CODICE CODE	ADATTO PER SUITABLE FOR	A	ØB
SERRANDA ANTIRITORNO 100 BACKDRAUGHT SHUTTER	0062200	Turbo 100	77	94
SERRANDA ANTIRITORNO 125 BACKDRAUGHT SHUTTER	0062300	Turbo 125	90	119
SERRANDA ANTIRITORNO 150/160 BACKDRAUGHT SHUTTER	0062100	AC – Turbo 150/160	100	156
SERRANDA ANTIRITORNO 200 BACKDRAUGHT SHUTTER	0062500	Turbo 200	127	194
SERRANDA ANTIRITORNO 250 BACKDRAUGHT SHUTTER	0062600	Turbo 250	152	244
SERRANDA ANTIRITORNO 315 BACKDRAUGHT SHUTTER	0062700	Turbo 315	185	309

GRIGLIA DI PROTEZIONE - PROTECTION GRILLE

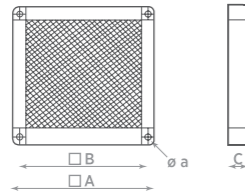

DESCRIZIONE DESCRIPTION	CODICE CODE	ADATTO PER SUITABLE FOR	A	B	C	ØA
GRIGLIA DI PROTEZIONE 200 PROTECTION GRILLE	0059400	AXIA LD-TT 20	310	268	52	9
GRIGLIA DI PROTEZIONE 250 PROTECTION GRILLE	0059500	AXIA LD-MD-HD-TT TT ECO 25	367	325	52	9
GRIGLIA DI PROTEZIONE 300 PROTECTION GRILLE	0059600	AXIA LD-MD-HD-TT TT ECO 30	424	382	52	9
GRIGLIA DI PROTEZIONE 350 PROTECTION GRILLE	0059700	AXIA LD-MD-HD-TT TT ECO 35	481	439	52	9
GRIGLIA DI PROTEZIONE 400 PROTECTION GRILLE	0059800	AXIA MD-HD-TT TT ECO 40	538	496	52	9
GRIGLIA DI PROTEZIONE 500 PROTECTION GRILLE	0059900	AXIA MD-HD-TT TT ECO 50	652	610	52	9
GRIGLIA DI PROTEZIONE 600 PROTECTION GRILLE	0060000	AXIA MD-HD-TT TT ECO 60	823	781	52	9

DISTANZIALE - SPACER

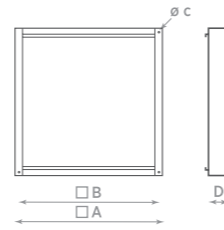
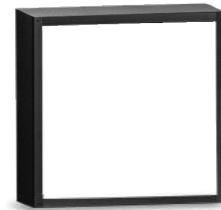

DESCRIZIONE DESCRIPTION	CODICE CODE	ADATTO PER SUITABLE FOR	A	B	C	D
DISTANZIALE D 200 SPACER	0065100	AXIA LD-TT 20	310	268	9	63
DISTANZIALE D 250 SPACER	0065200	AXIA LD-MD-HD-TT TT ECO 25	367	325	9	73
DISTANZIALE D 300 SPACER	0065300	AXIA LD-MD-HD-TT TT ECO 30	424	382	9	75,5
DISTANZIALE D 350 SPACER	0065400	AXIA LD-MD-HD-TT TT ECO 35	481	439	9	101,5
DISTANZIALE D 400 SPACER	0065500	AXIA MD-HD-TT TT ECO 40	538	496	9	116,5
DISTANZIALE D 500 SPACER	0065600	AXIA MD-HD-TT TT ECO 50	652	610	9	119,5
DISTANZIALE D 600 SPACER	0065700	AXIA MD-HD-TT TT ECO 60	823	781	9	130,5

SERRANDA A GRAVITÀ ABS ABS GRAVITY SHUTTER

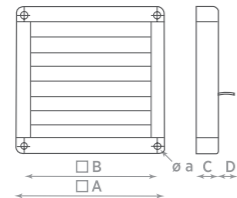

DESCRIZIONE DESCRIPTION	CODICE CODE	ADATTO PER SUITABLE FOR	A	B	C	D	ØA
SERRANDA A GRAVITÀ 200 GRAVITY SHUTTER	0060100	AXIA LD-TT 20	310	268	52	54	9
SERRANDA A GRAVITÀ 250 GRAVITY SHUTTER	0060200	AXIA LD-MD-HD TT-TT ECO 25	367	325	52	54	9
SERRANDA A GRAVITÀ 300 GRAVITY SHUTTER	0060300	AXIA LD-MD-HD TT-TT ECO 30	424	382	52	54	9
SERRANDA A GRAVITÀ 350 GRAVITY SHUTTER	0060400	AXIA LD-MD-HD TT-TT ECO 35	481	439	52	54	9
SERRANDA A GRAVITÀ 400 GRAVITY SHUTTER	0060500	AXIA MD-HD TT-TT ECO 40	538	496	52	54	9

SERRANDA A GRAVITÀ METALLO METAL GRAVITY SHUTTER

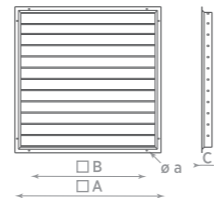

DESCRIZIONE DESCRIPTION	CODICE CODE	ADATTO PER SUITABLE FOR	A	B	C	ØA
SERRANDA A GRAVITÀ 500 METALLO METAL GRAVITY SHUTTER	0060610	AXIA MD-HD TT-TT ECO 50	650	525	45	5
SERRANDA A GRAVITÀ 600 METALLO METAL GRAVITY SHUTTER	0060710	AXIA MD-HD TT-TT ECO 60	821	696	45	5

RETE PIANA - SAFETY PROTECTION GRILLE

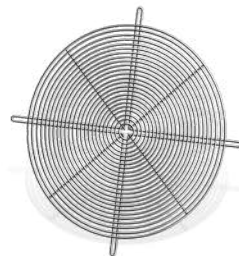

DESCRIZIONE DESCRIPTION	CODICE CODE	ADATTO PER SUITABLE FOR
RETE PIANA AI R 30 SAFETY PROTECTION GRILLE	0072983	AXIA AI - AI ECO - AI HP 30
RETE PIANA AI R 35 SAFETY PROTECTION GRILLE	0072984	AXIA AI - AI ECO - AI HP 35
RETE PIANA AI R 40 SAFETY PROTECTION GRILLE	0072985	AXIA AI - AI ECO - AI HP 40
RETE PIANA AI R 45 SAFETY PROTECTION GRILLE	0072986	AXIA AI - AI ECO - AI HP 45
RETE PIANA AI R 50 SAFETY PROTECTION GRILLE	0072987	AXIA AI - AI ECO - AI HP 50
RETE PIANA AI R 60 SAFETY PROTECTION GRILLE	0072949	AXIA AI - AI ECO - AI HP 60

FLANGIA PIANA - CONNECTION FLANGE



DESCRIZIONE DESCRIPTION	CODICE CODE	ADATTO PER SUITABLE FOR
FLANGIA PIANA AI F 30 CONNECTION FLANGE	0072995	AXIA AI - AI ECO - AI HP 30
FLANGIA PIANA AI F 35 CONNECTION FLANGE	0072996	AXIA AI - AI ECO - AI HP 35
FLANGIA PIANA AI F 40 CONNECTION FLANGE	0072997	AXIA AI - AI ECO - AI HP 40
FLANGIA PIANA AI F 45 CONNECTION FLANGE	0072998	AXIA AI - AI ECO - AI HP 45
FLANGIA PIANA AI F 50 CONNECTION FLANGE	0072999	AXIA AI - AI ECO - AI HP 50
FLANGIA PIANA AI F 60 CONNECTION FLANGE	0072948	AXIA AI - AI ECO - AI HP 60

ANELLO DI PROLUNGA - EXTENSION RING



DESCRIZIONE DESCRIPTION	CODICE CODE	ADATTO PER SERIE SUITABLE FOR
ANELLO DI PROLUNGA AI PRO 30 EXTENSION RING	0072908	AXIA AI - AI ECO - AI HP 30
ANELLO DI PROLUNGA AI PRO 35 EXTENSION RING	0072913	AXIA AI - AI ECO - AI HP 35
ANELLO DI PROLUNGA AI PRO 40 EXTENSION RING	0072918	AXIA AI - AI ECO - AI HP 40
ANELLO DI PROLUNGA AI PRO 45 EXTENSION RING	0072923	AXIA AI - AI ECO - AI HP 45
ANELLO DI PROLUNGA AI PRO 50 EXTENSION RING	0072928	AXIA AI - AI ECO - AI HP 50
ANELLO DI PROLUNGA AI PRO 60 EXTENSION RING	0072947	AXIA AI - AI ECO - AI HP 60

GIUNTO ANTIVIBRANTE - FLEXIBLE CONNECTION



DESCRIZIONE DESCRIPTION	CODICE CODE	ADATTO PER SUITABLE FOR
GIUNTO ANTIVIBRANTE AI G 30 FLEXIBLE CONNECTION	0072977	AXIA AI - AI ECO - AI HP 30
GIUNTO ANTIVIBRANTE AI G 35 FLEXIBLE CONNECTION	0072978	AXIA AI - AI ECO - AI HP 35
GIUNTO ANTIVIBRANTE AI G 40 FLEXIBLE CONNECTION	0072979	AXIA AI - AI ECO - AI HP 40
GIUNTO ANTIVIBRANTE AI G 45 FLEXIBLE CONNECTION	0072980	AXIA AI - AI ECO - AI HP 45
GIUNTO ANTIVIBRANTE AI G 50 FLEXIBLE CONNECTION	0072981	AXIA AI - AI ECO - AI HP 50
GIUNTO ANTIVIBRANTE AI G 60 FLEXIBLE CONNECTION	0072944	AXIA AI - AI ECO - AI HP 60

SUPPORTO - SUPPORT

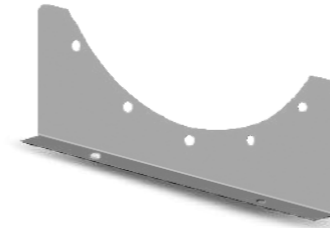

DESCRIZIONE DESCRIPTION	CODICE CODE	ADATTO PER SERIE SUITABLE FOR
SUPPORTO AI SP 30 SUPPORT	0072989	AXIA AI - AI ECO - AI HP 30
SUPPORTO AI SP 35 SUPPORT	0072990	AXIA AI - AI ECO - AI HP 35
SUPPORTO AI SP 40 SUPPORT	0072991	AXIA AI - AI ECO - AI HP 40
SUPPORTO AI SP 45 SUPPORT	0072992	AXIA AI - AI ECO - AI HP 45
SUPPORTO AI SP 50 SUPPORT	0072993	AXIA AI - AI ECO - AI HP 50
SUPPORTO AI SP 60 SUPPORT	0072943	AXIA AI - AI ECO - AI HP 60

SERRANDA A GRAVITÀ - GRAVITY SHUTTER

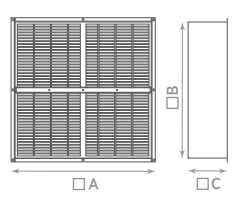
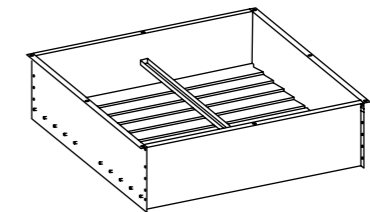

DESCRIZIONE DESCRIPTION	CODICE CODE	ADATTO PER SERIE SUITABLE FOR	A	B	ØC
SERRANDA A GRAVITÀ SG GRAVITY SHUTTER	0055110	TXA 40	480	440	176
SERRANDA A GRAVITÀ SG GRAVITY SHUTTER	0055120	TXA 50	590	550	195
SERRANDA A GRAVITÀ SG GRAVITY SHUTTER	0055130	TXA 63	720	683	200
SERRANDA A GRAVITÀ SG GRAVITY SHUTTER	0055140	TXA 71	797	760	201
SERRANDA A GRAVITÀ SG GRAVITY SHUTTER	0055150	TXA 80	1060	1020	133
SERRANDA A GRAVITÀ SG GRAVITY SHUTTER	0055160	TXA 100	1230	1190	135

CONTROTELAIO DI BASE - FRAME BASE

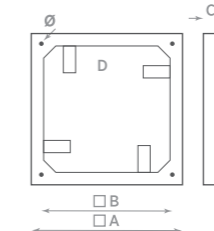
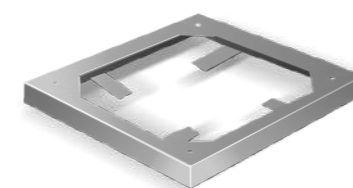

DESCRIZIONE DESCRIPTION	CODICE CODE	ADATTO PER SERIE SUITABLE FOR	A	B	C	ØD	KG
CONTROTELAIO TXP - TXV 3/6 FRAME BASE	0080600	TXP-TXV / TXP TXV 400°C/2h	390	350	40	11,2	0,8
CONTROTELAIO TXP - TXV 7/8 FRAME BASE	0080700	TXP-TXV / TXP TXV 400°C/2h	550	460	40	11,2	1,6
CONTROTELAIO TXP - TXV 10 FRAME BASE	0080800	TXP-TXV / TXP TXV 400°C/2h	700	610	40	11,2	2
CONTROTELAIO TXP - TXV 12/14/15/18 FRAME BASE	0080900	TXP-TXV / TXP TXV 400°C/2h	890	800	40	11,2	3,2

SERRANDA A GRAVITÀ - GRAVITY SHUTTER

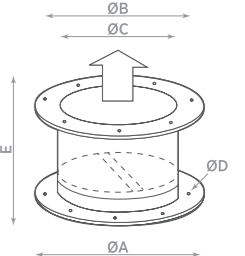

DESCRIZIONE DESCRIPTION	CODICE CODE	ADATTO PER SUITABLE FOR	ØA	ØB	ØC	ØD	E	KG
S. A G. TXP - TXV 3 G. S.	0078600	TXP-TXV	259	235	200	3xM8	150	1,1
S. A G. TXP - TXV 6 G. S.	0078700	TXP-TXV	309	283	250	3xM8	210	1,8
S. A G. TXP - TXV 7 G. S.	0078800	TXP-TXV	359	330	300	3xM8	210	2,6
S. A G. TXP - TXV 8 G. S.	0078900	TXP-TXV	409	381	350	4xM8	230	3,4
S. A G. TXP - TXV 10 G. S.	0079000	TXP-TXV	460	431	400	4xM8	250	4,2
S. A G. TXP - TXV 12 G. S.	0079100	TXP-TXV	560	533	500	5xM8	300	5,8
S. A G. TXP - TXV 14 G. S.	0079200	TXP-TXV	620	585	550	6xM8	320	6,6
S. A G. TXP - TXV 15/18 G. S.	0079300	TXP-TXV	661	636	600	7xM8	320	7,3

ACCESSORI – ACCESSORIES

RACCORDO QUADRO TONDO CONNECTION SQUARE TO ROUND

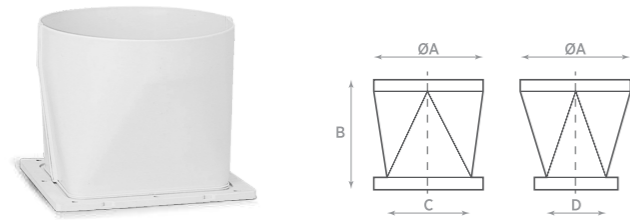

DESCRIZIONE DESCRIPTION	CODICE CODE	ADATTO PER SUITABLE FOR	ØA	B	C	D
RACCORDO PER CAA 610 OUTLET FOR	0063000	CAA 610	125	105	90	90
RACCORDO PER CAA 620 OUTLET FOR	0063100	CAA 620	200	160	165	135
RACCORDO PER CAA 630 OUTLET FOR	0063200	CAA 630	250	160	205	165
RACCORDO PER CAA 640 Ø 315 OUTLET FOR	0063400	CAA 640	315	200	245	205
RACCORDO PER CAA 650 Ø 315 OUTLET FOR	0063500	CAA 650	315	205	290	235
RACCORDO PER CAA 650 Ø 355 OUTLET FOR	0063600	CAA 650	355	205	290	235

RIDUTTORE – REDUCER

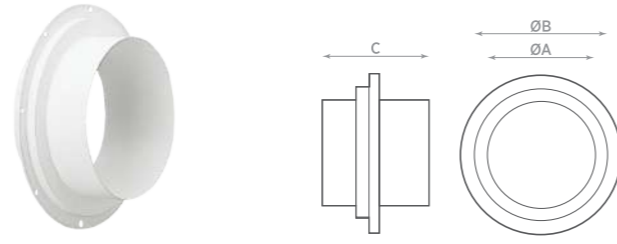

DESCRIZIONE DESCRIPTION	CODICE CODE	ADATTO PER SUITABLE FOR	ØA	ØB	C
RIDUTTORE Ø315/250 – CAA 640 REDUCER	0066800	CAA 640	250	315	147

RACCORDO AD ANGOLO – ANGLED OUTLET

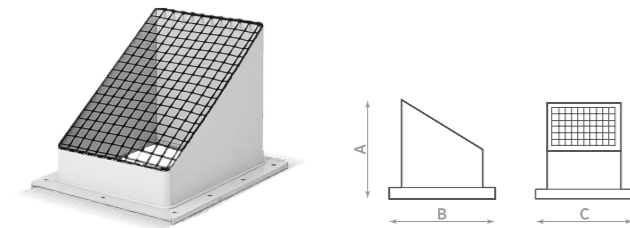

DESCRIZIONE DESCRIPTION	CODICE CODE	ADATTO PER SUITABLE FOR	A	B	C
RACCORDO AD ANGOLO ANGLED OUTLET	0067700	CAA 610	90	90	90
RACCORDO AD ANGOLO ANGLED OUTLET	0067800	CAA 620	160	165	135
RACCORDO AD ANGOLO ANGLED OUTLET	0067900	CAA 630	208	205	165
RACCORDO AD ANGOLO ANGLED OUTLET	0068000	CAA 640	60	245	205
RACCORDO AD ANGOLO ANGLED OUTLET	0068100	CAA 650	260	290	235

SERRANDA – SHUTTER

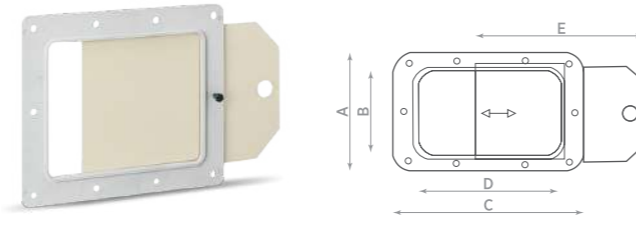

DESCRIZIONE DESCRIPTION	CODICE CODE	ADATTO PER SUITABLE FOR	A	B	C	D	E
SERRANDA SHUTTER	0066900	CAA 630	230	165	265	205	274
SERRANDA SHUTTER	0067000	CAA 640	263	205	303	245	332
SERRANDA SHUTTER	0067100	CAA 650	305	235	355	290	372

ORIENTAMENTO COCLEA IMPELLER HOUSING ROTATION

DIREZIONE DI USCITA E ROTAZIONE VISTE DEL LATO MOTORE OUTPUT DIRECTION AND HOUSING ROTATION VIEWED FROM MOTOR SIDE

NORMA AMCA standard 99 – 2406 – 83

Rotazione antioraria CCW (LG)

Counter clockwise rotation CCW (LG)

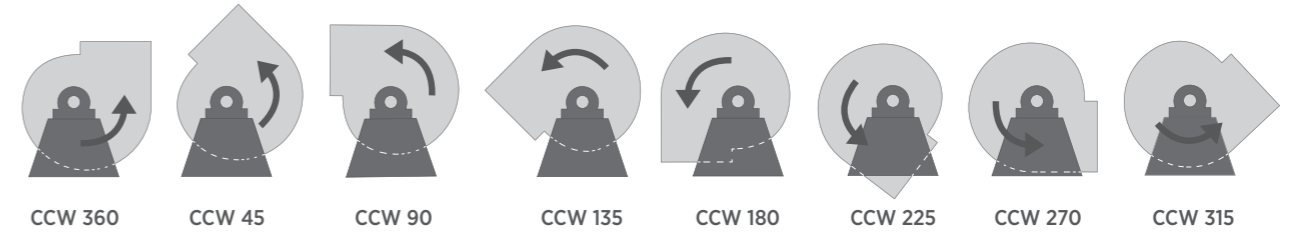

Rotazione oraria CW (RD)

Clockwise rotation CW (RD)

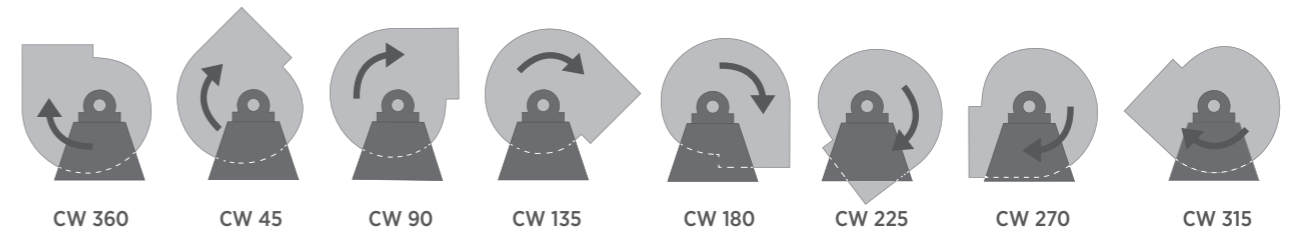

CE Tutti i prodotti contenuti in questo catalogo sono conformi ai requisiti essenziali previsti dalle Direttive Comunitarie.
All products included in this catalogue meet the essential requirements of EU directives.

Al fine di migliorare la propria offerta, O.ERRE si riserva il diritto di variare misure, caratteristiche e design o eliminare intere referenze dei propri prodotti senza preavviso.

In order to improve its offer, O.ERRE reserves the right to change sizes, features and design, or delete entire references of its products without notice.

Via del Commercio 1 - 25039
Travagliato (BS) - ITALY
Ph. +39 030 68 62 341
Fax +39 030 25 84 012
vendite@oerre.it

www.oerre.eu

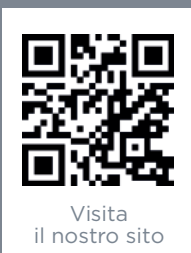
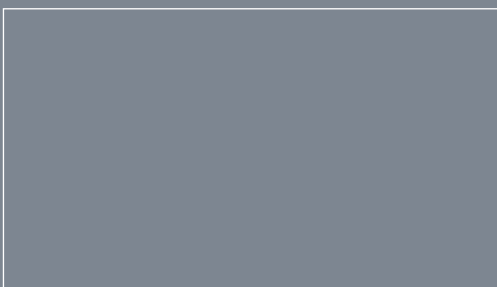

Visita
il nostro sito

www.oerre.eu